

SCI-FI GOTHIC COLLECTION

RUINED WALLS 1

ASSEMBLY INSTRUCTIONS



BEFORE ASSEMBLING YOUR KIT, CAREFULLY READ THE FOLLOWING INSTRUCTIONS.

To assemble this kit, you will need several tools:

A modelling knife

Use the modelling knife to detach the pieces from their frame. Do not push them with your fingers or you might break the most fragile parts.

Sandpaper or a small wood file

Sand or file away any rough edges where the parts were attached to the panel.

Wood glue or liquid cyanoacrylate

Glue the pieces according to the assembly plan. Wood glue will take longer to dry than cyanoacrylate glue, but is easier to reposition in case of error.

When assembling this kit, make sure the pieces fit together properly before gluing them together.

You may find some of these icons in the assembly plan.
They will provide you with additional information for your assembly.



Indicates
the direction
of gluing



Do not glue



Align



Important
note



Construction
stage



End
of stage



Assembly
alternatives

AVANT D'ASSEMBLER VOTRE KIT, LISEZ ATTENTIVEMENT LES INSTRUCTIONS SUIVANTES.

Pour assembler ce kit, vous aurez besoin de plusieurs outils :

Un couteau de modélisme

Utilisez le couteau de modélisme pour détacher les pièces de leur cadre. Ne poussez pas avec vos doigts car vous risqueriez de casser les pièces les plus fragiles.

Du papier abrasif ou une petite lime à bois

Poncez ou limez les aspérités, là où les pièces étaient attachées au panneau.

De la colle à bois ou cyanoacrylate liquide

Collez les pièces suivant le plan de montage. La colle à bois mettra plus de temps à sécher que la colle cyanoacrylate, mais est plus facilement repositionnable en cas d'erreur.

Lorsque vous assemblez ce kit, vérifiez avant de coller si les pièces s'emboîtent correctement.

Vous trouverez peut-être certaines de ces icônes dans le plan de montage.
Elles vous fourniront des informations complémentaires pour votre assemblage.



Indique
la direction
du collage

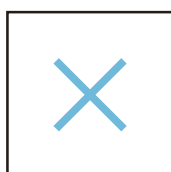

Ne pas
coller

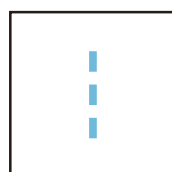

Aligner



Remarque
importante

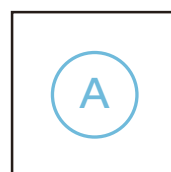

Etape de
construction



Fin
d'étape



Alternatives de
montage

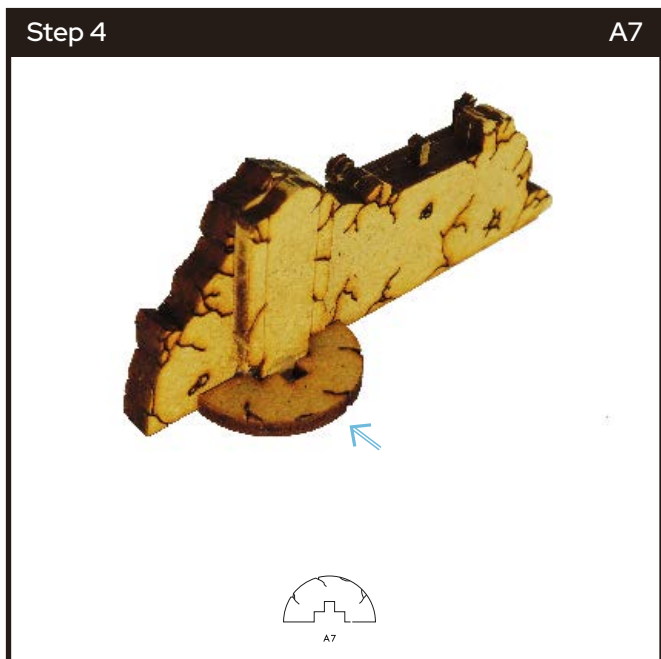
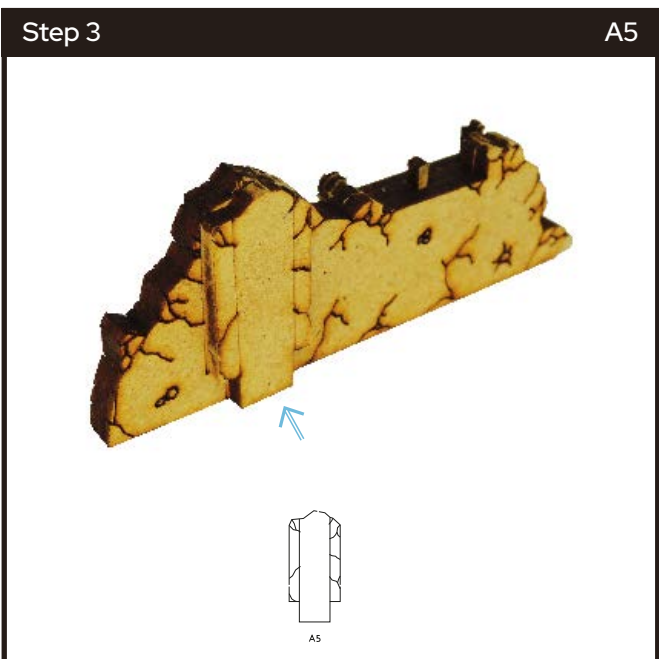
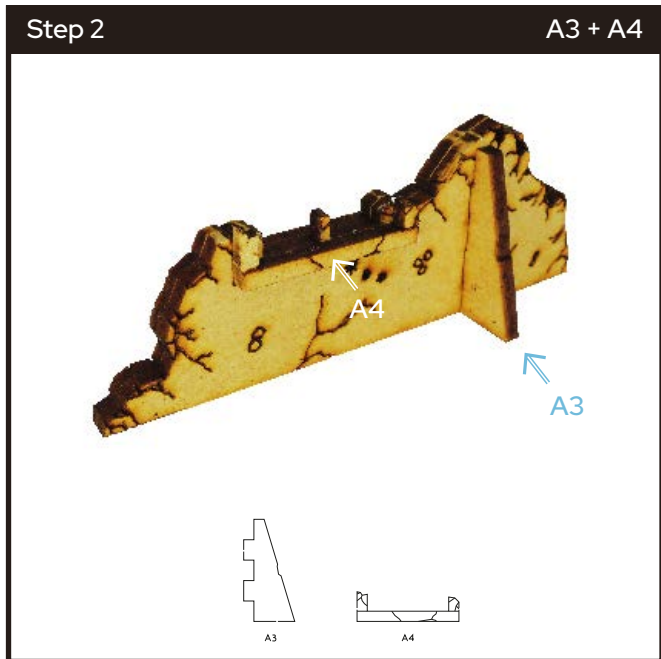
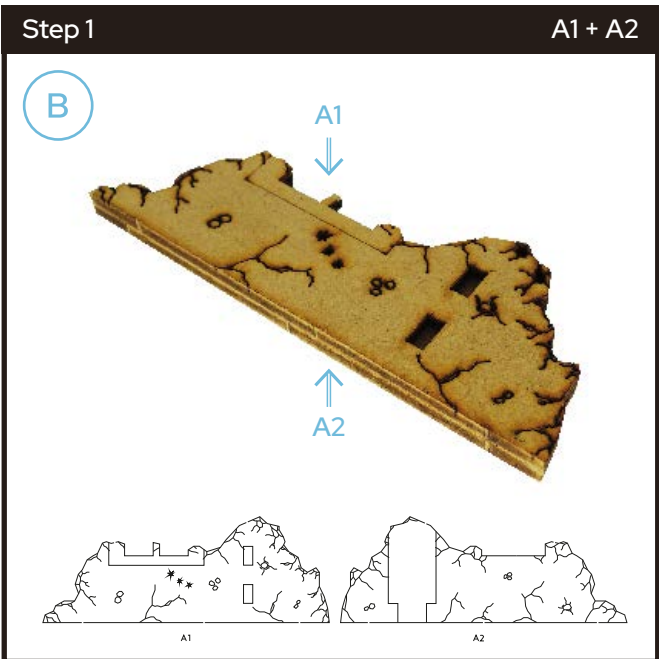
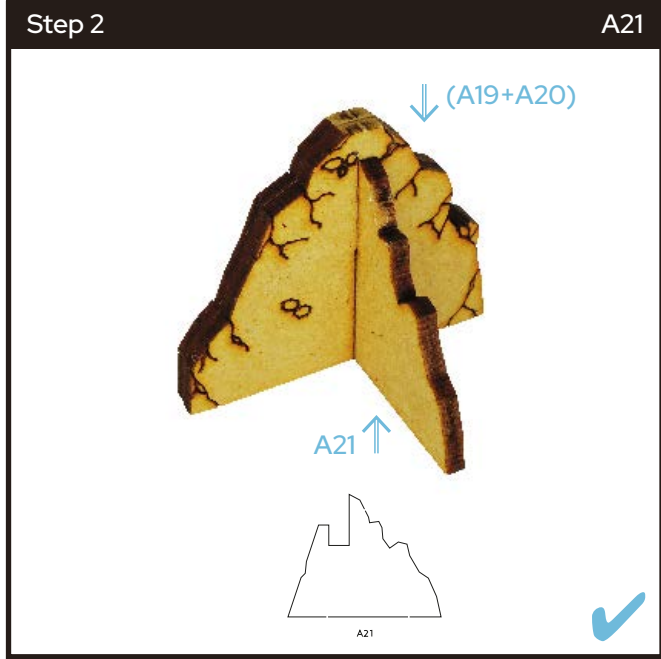
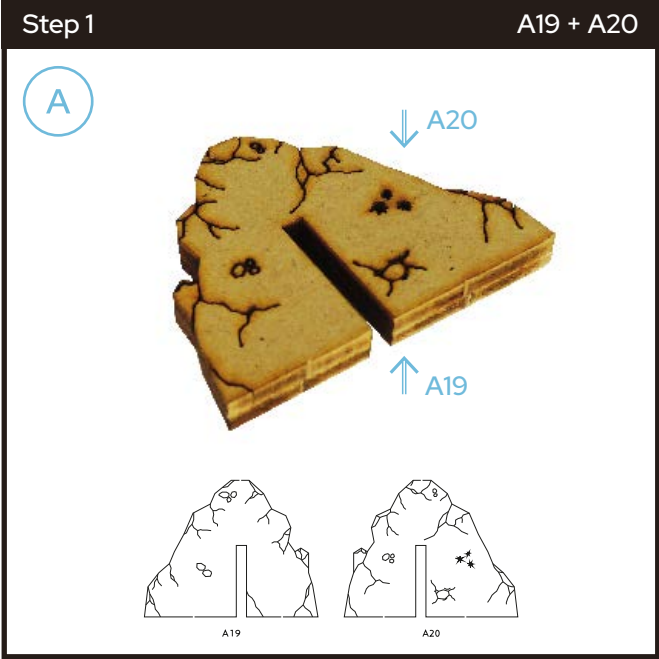

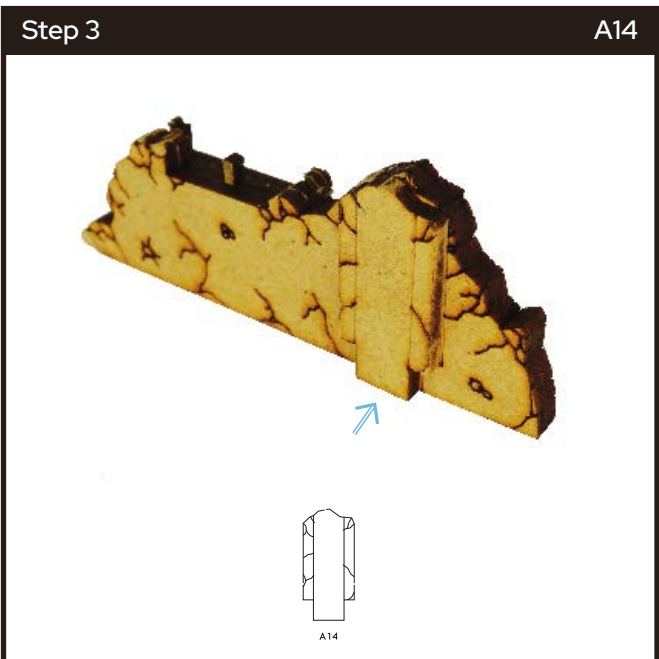
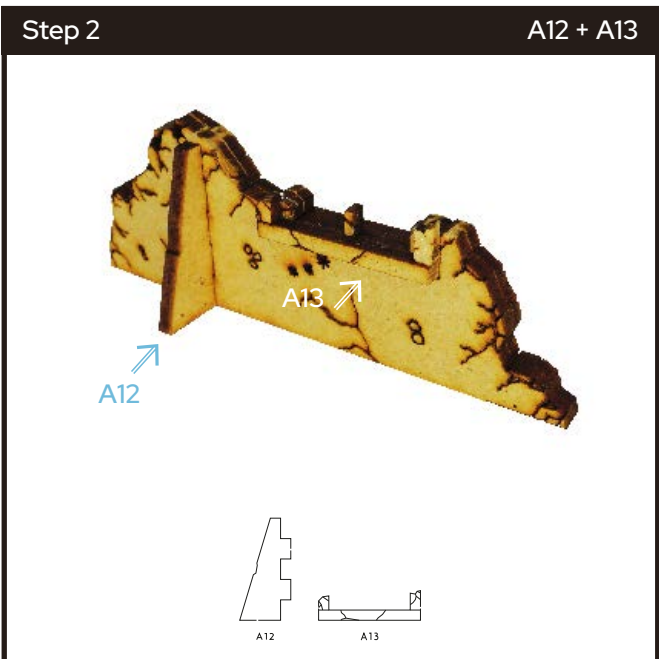
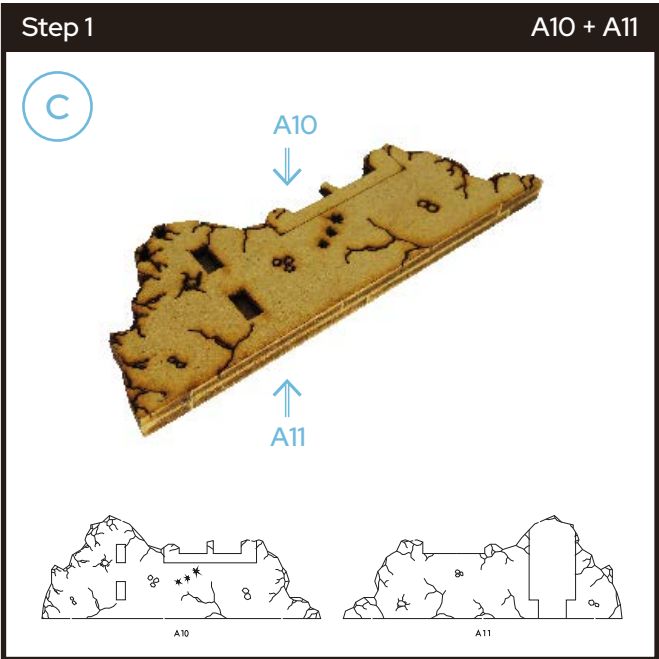

Step 4

A16

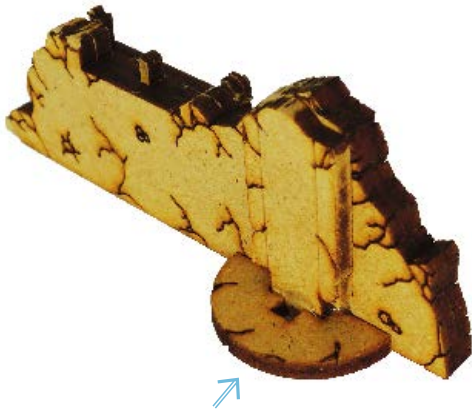

A16

Step 5

A17

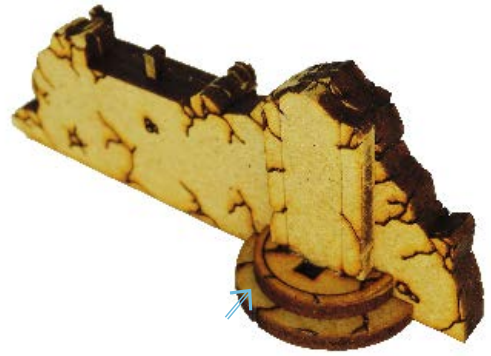

A17

Step 6

A15

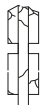
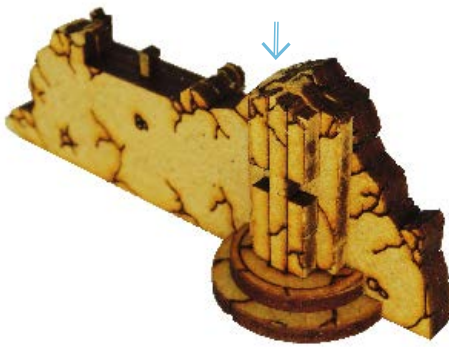

A15

Step 7

A18

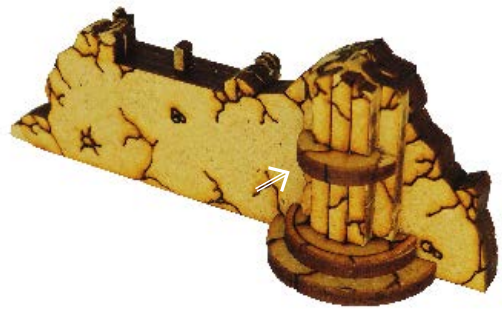

A18



Step 1

A22 + A23

D

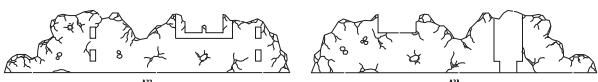
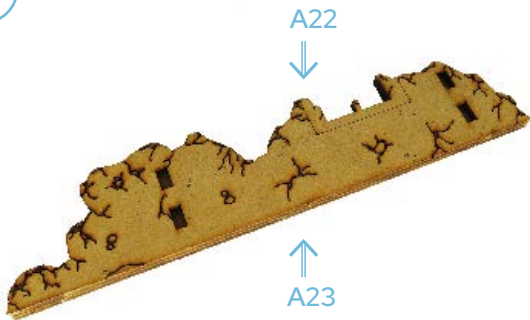

A22

A23

Step 2

A24 + A25 + A26

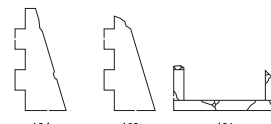
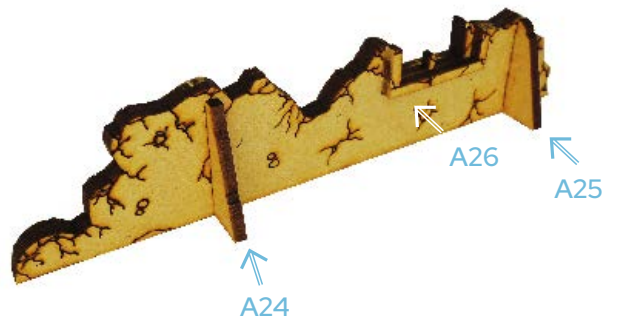

A24

A25

A26

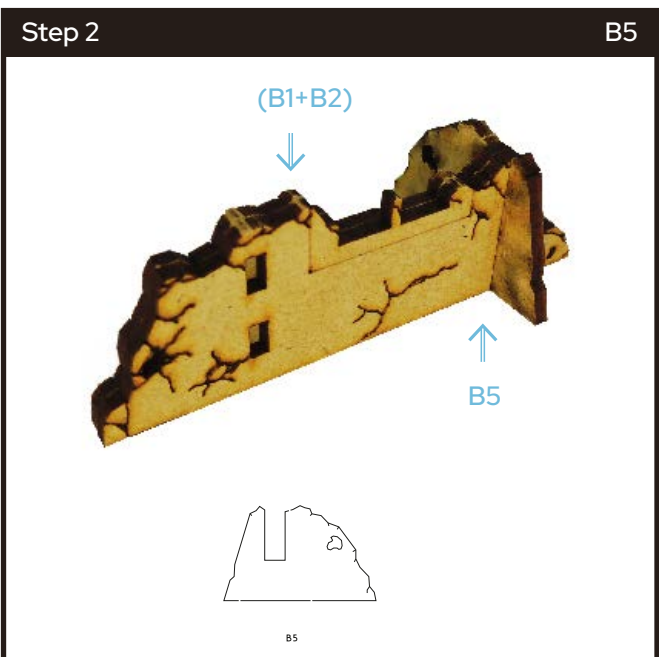
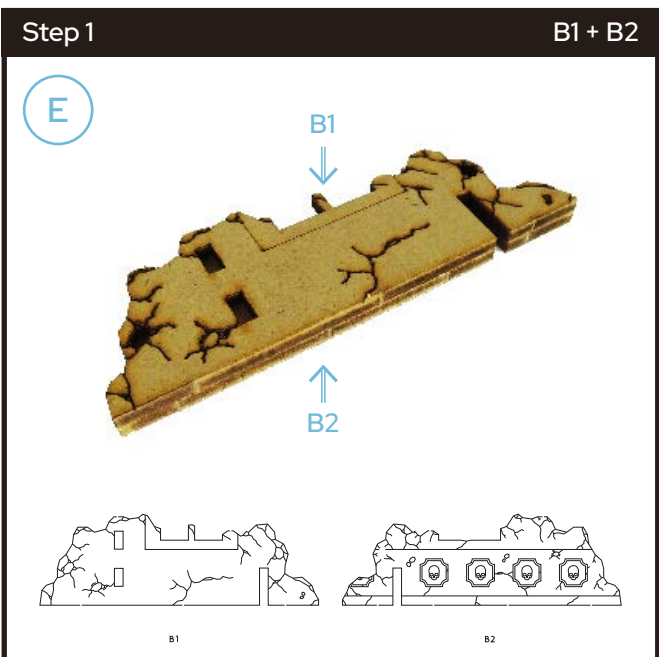
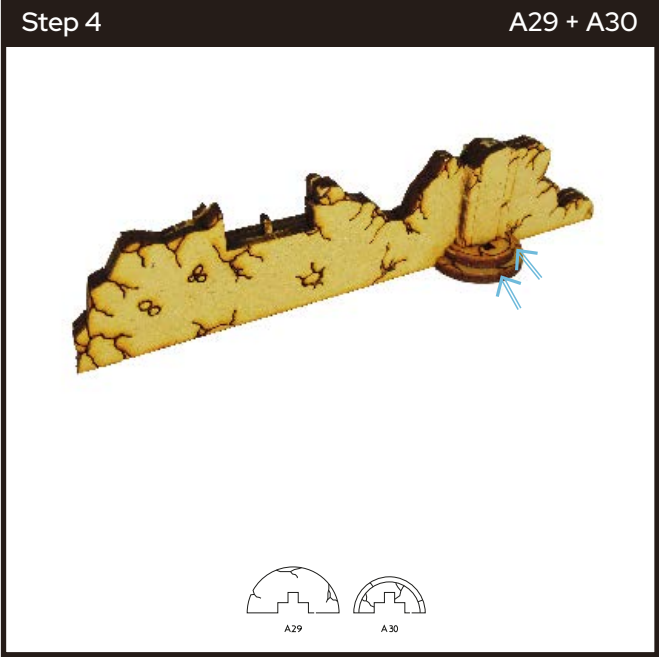

Step 3 **B3 + B4**

B3

B4

B3

B4

Step 1 **B6 + B7**

(F)

B7

B6

B6

B7

Step 2 **B17 + B18**

B18

B17

B17

B18

Step 3 **B8 + B9 + B10**

B9

B10

B8

B8

B9

B10

Step 4 **B11 + B12 + B13**

B12

B13

B11

B11

B12

B13

Step 5 **B14 + B15 + B16**

B16

B15

B14

B14

B15

B16

Step 1

B19 + B20

G

B19

B20

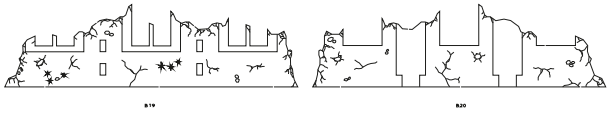
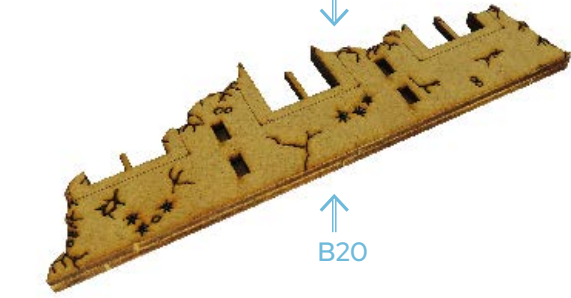

Step 2

B21 + B22 + B23

B22

B23

B21

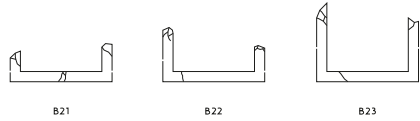
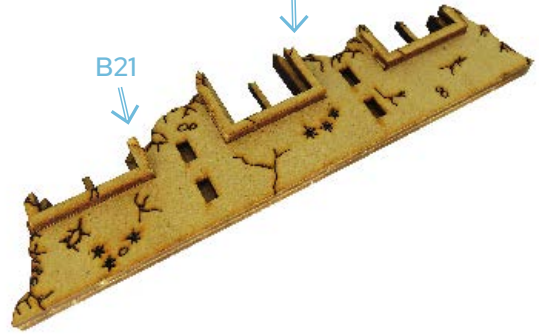

Step 3

B24 + B25

B25

B24

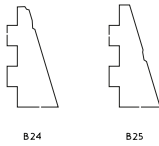
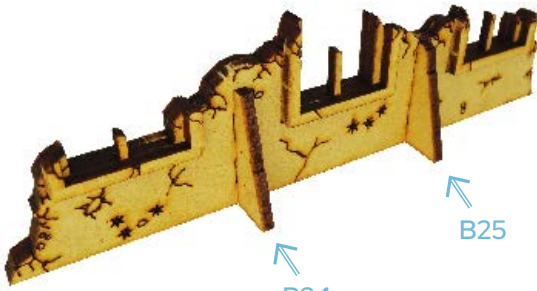

Step 4

B26 + B28

B26

B28

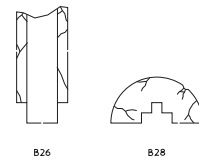
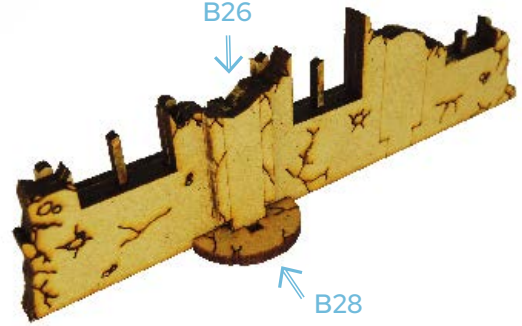

Step 5

B27 + B29

B27

B29

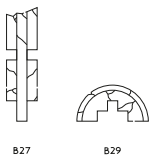
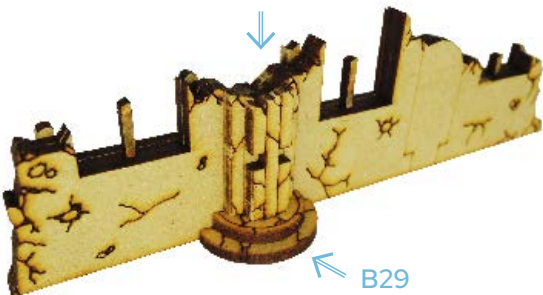

Step 6

B30

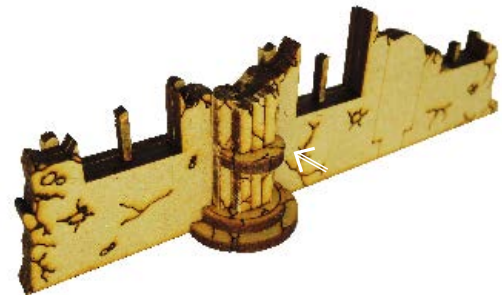

Step 7

B28

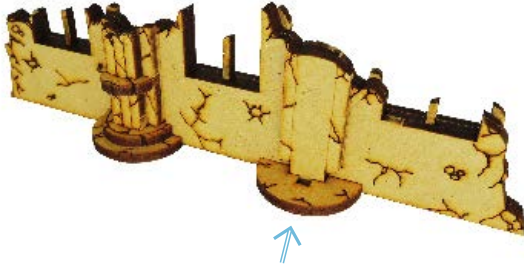

B28

Step 8

B27 + B29

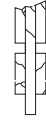
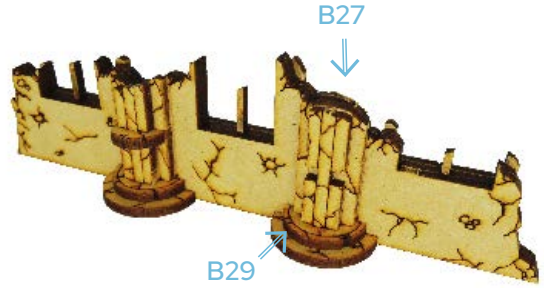

B27



B29

Step 9

B30

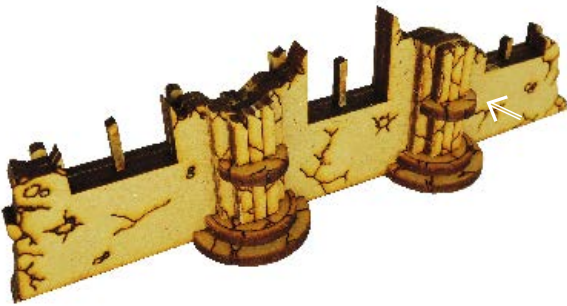

B30



A



B



C



D



E



F



G



A



B



D



F

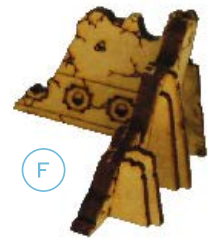

C

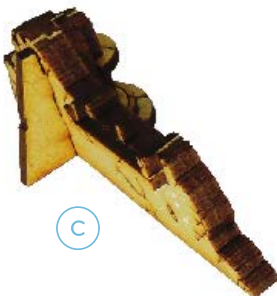

G



E

