

SCI-FI GOTHIC COLLECTION

# MEMORIAL

ASSEMBLY INSTRUCTIONS



## **BEFORE ASSEMBLING YOUR KIT, CAREFULLY READ THE FOLLOWING INSTRUCTIONS.**

To assemble this kit, you will need several tools:

### **A modelling knife**

Use the modelling knife to detach the pieces from their frame. Do not push them with your fingers or you might break the most fragile parts.

### **Sandpaper or a small wood file**

Sand or file away any rough edges where the parts were attached to the panel.

### **Wood glue or liquid cyanoacrylate**

Glue the pieces according to the assembly plan. Wood glue will take longer to dry than cyanoacrylate glue, but is easier to reposition in case of error.

When assembling this kit, make sure the pieces fit together properly before gluing them together.

You may find some of these icons in the assembly plan. They will provide you with additional information for your assembly.



Indicates the direction of gluing



Do not glue



Align



Important note



Construction stage



End of stage



Assembly alternatives

## **AVANT D'ASSEMBLER VOTRE KIT, LISEZ ATTENTIVEMENT LES INSTRUCTIONS SUIVANTES.**

Pour assembler ce kit, vous aurez besoin de plusieurs outils :

### **Un couteau de modélisme**

Utilisez le couteau de modélisme pour détacher les pièces de leur cadre. Ne poussez pas avec vos doigts car vous risqueriez de casser les pièces les plus fragiles.

### **Du papier abrasif ou une petite lime à bois**

Poncez ou limez les aspérités, là où les pièces étaient attachées au panneau.

### **De la colle à bois ou cyanoacrylate liquide**

Collez les pièces suivant le plan de montage. La colle à bois mettra plus de temps à sécher que la colle cyanoacrylate, mais est plus facilement repositionnable en cas d'erreur.

Lorsque vous assemblez ce kit, vérifiez avant de coller si les pièces s'emboîtent correctement.

Vous trouverez peut-être certaines de ces icônes dans le plan de montage. Elles vous fourniront des informations complémentaires pour votre assemblage.



Indique la direction du collage

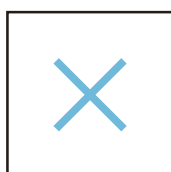

Ne pas coller

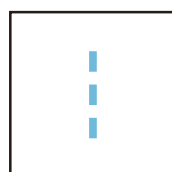

Aligner



Remarque importante

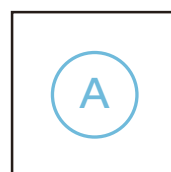

Etape de construction



Fin d'étape



Alternatives de montage

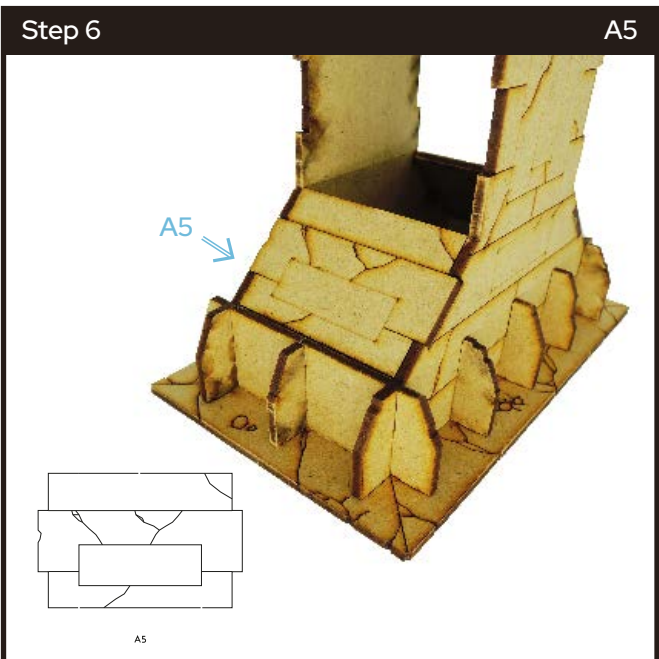
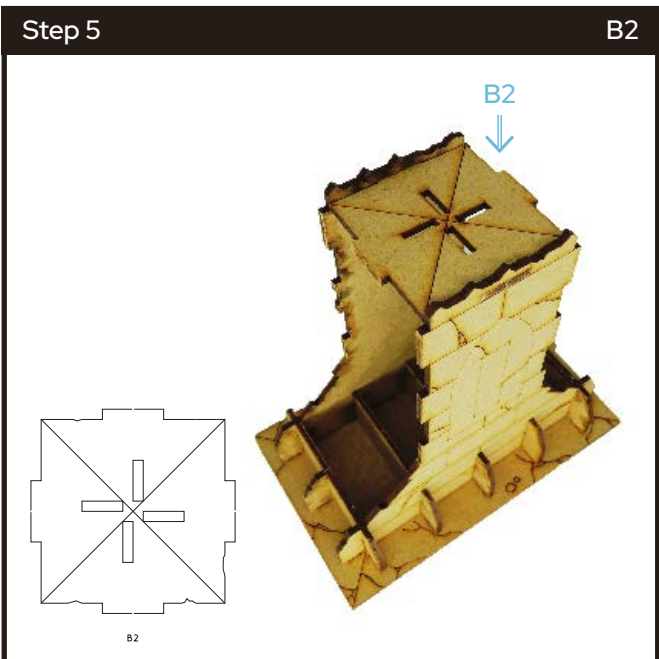
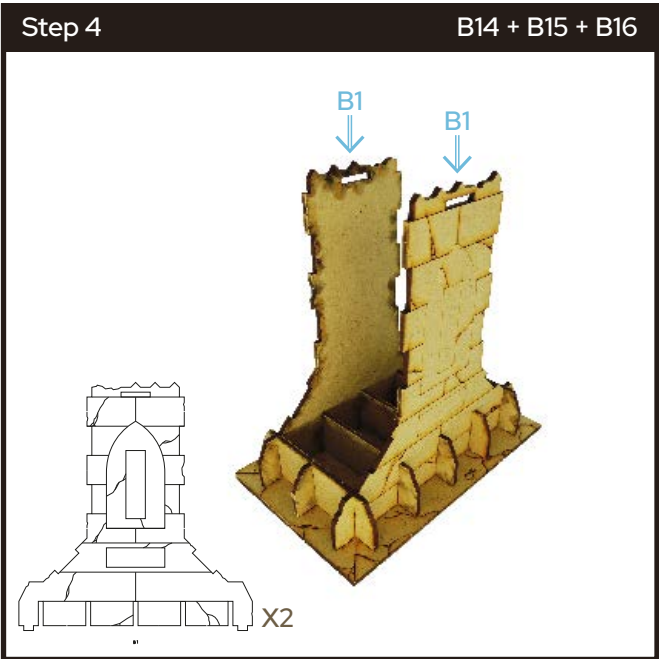
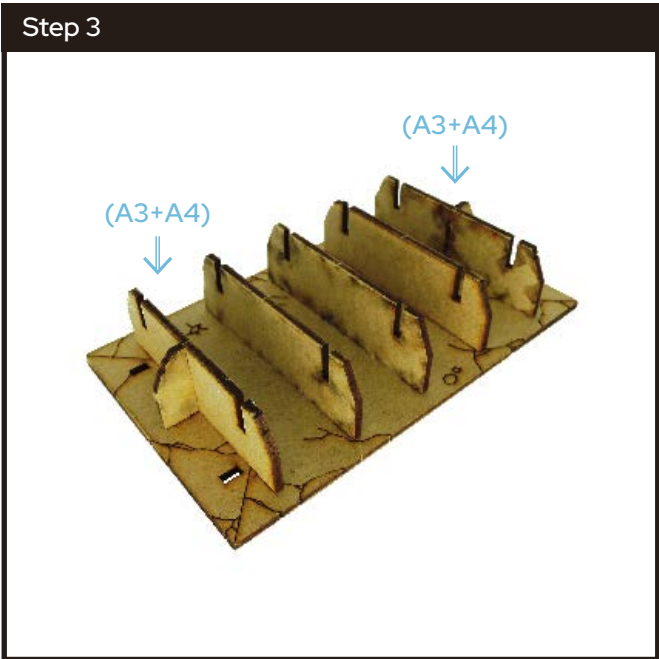
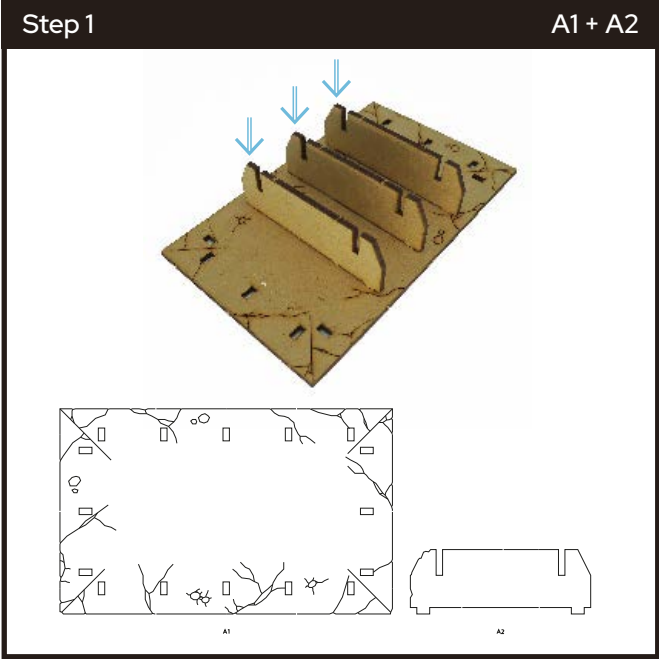

Step 7

A5

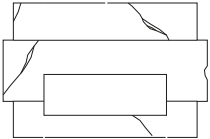
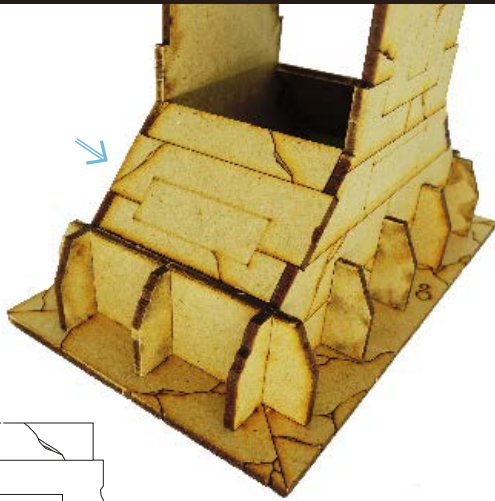

A5

Step 8

A6

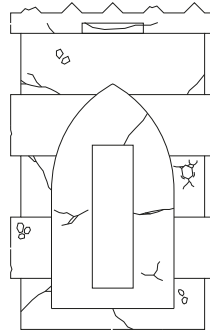
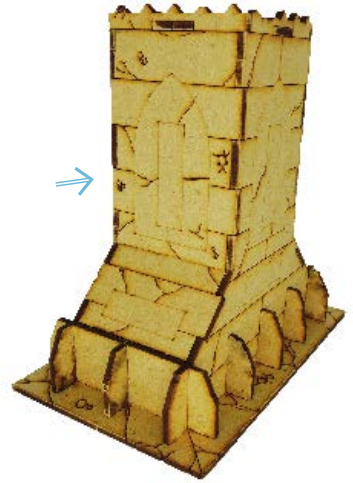

A6

Step 9

A6

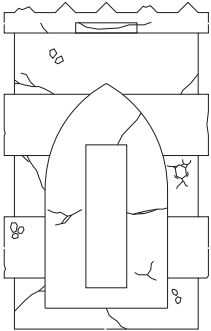
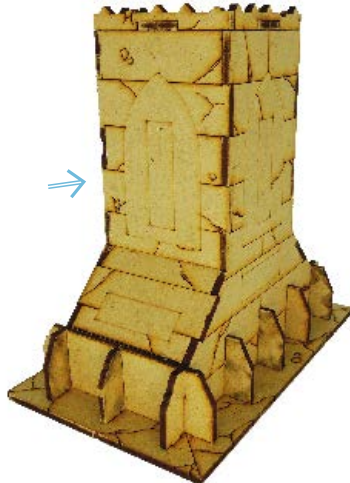

A6

Step 10

B5

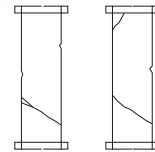
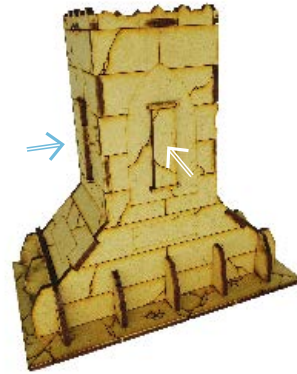

B5

B5

Step 11

B5

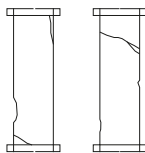
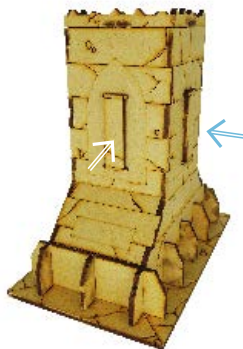

B5

B5

Step 12

B4

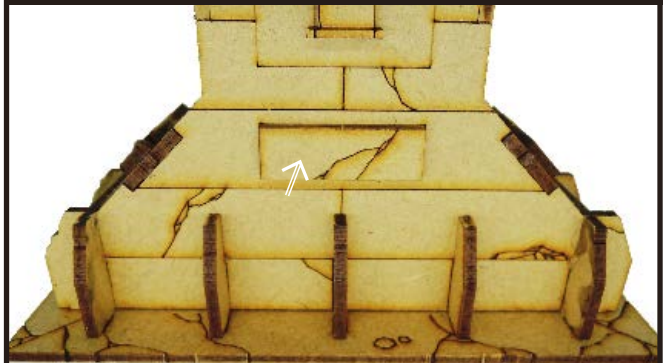

B4

Step 13

B4



B4

Step 14

B4



B4

Step 15

B4

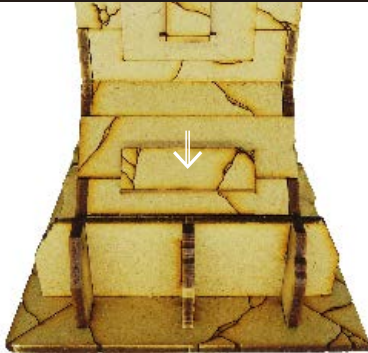

B4

Step 16

B3

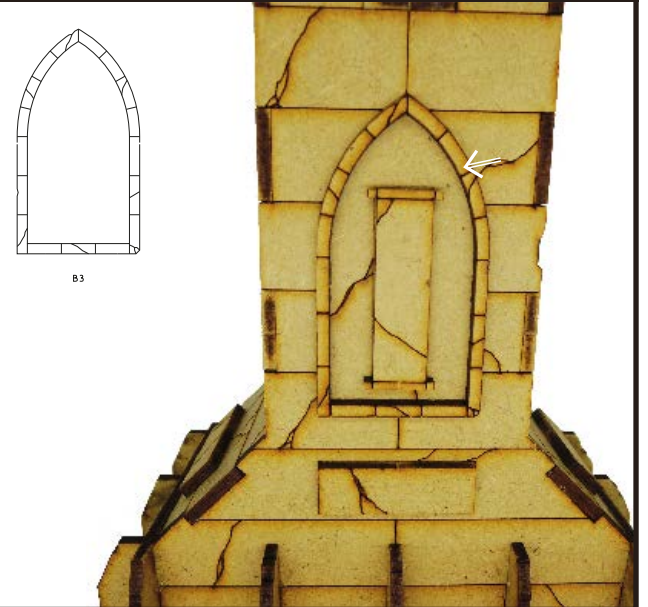

B3

Step 17

B3

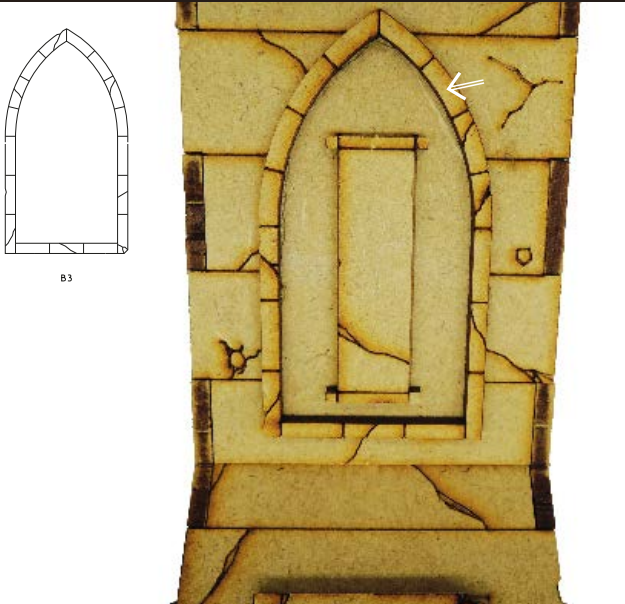

B3

Step 18

B3

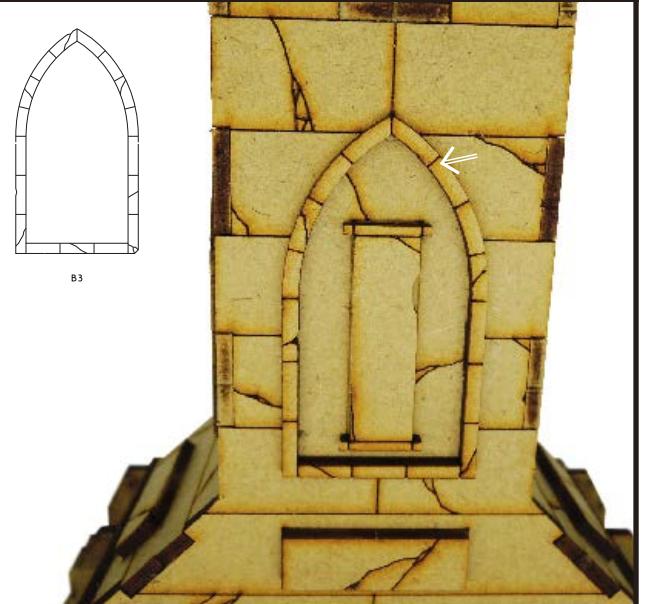

B3

Step 19

B3

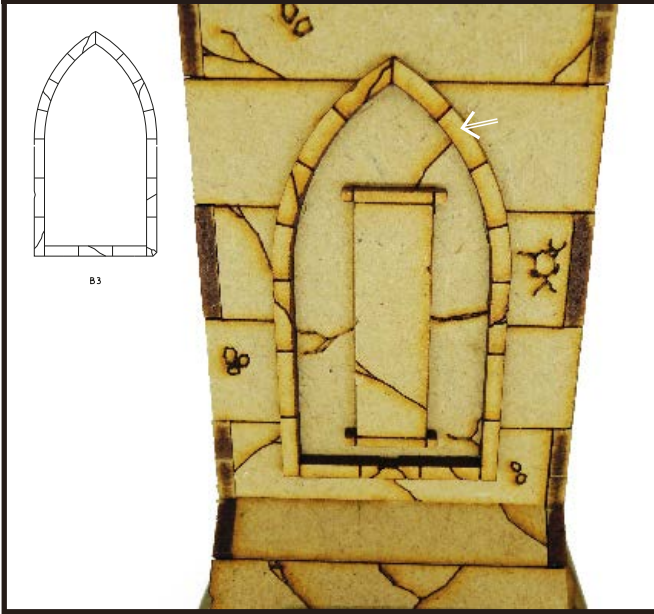

Step 20

A7

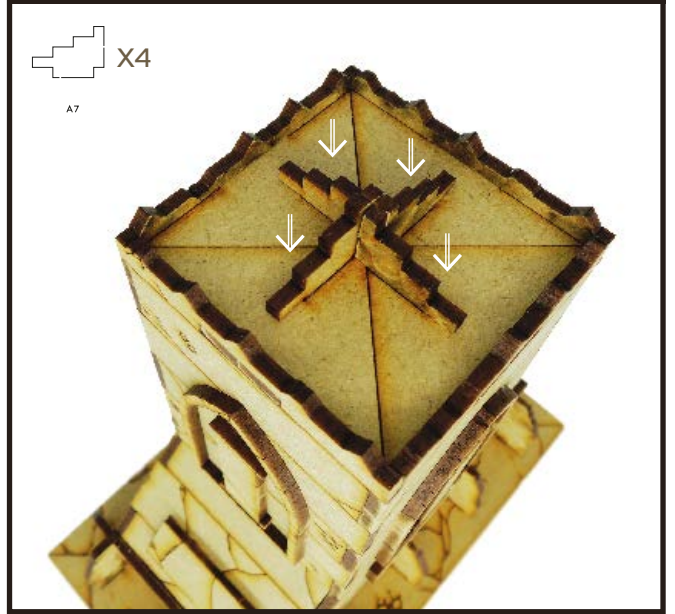

Step 21

B6

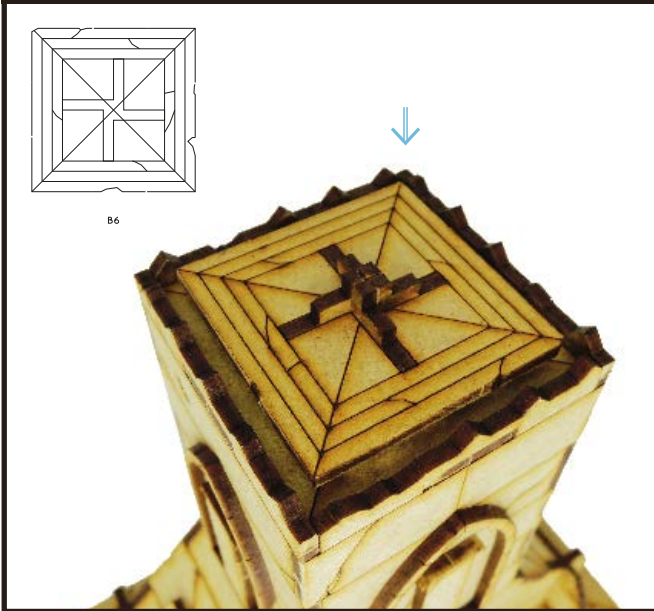

Step 22

B7

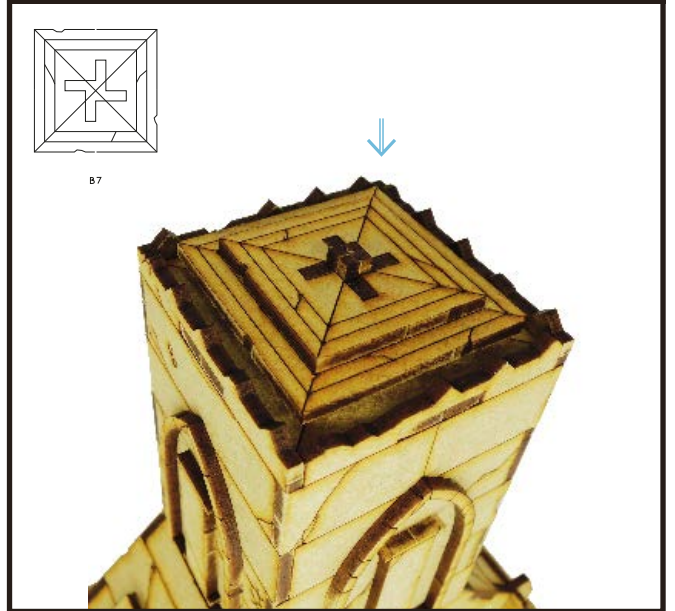

Step 23

B8



Step 24

B9

