

SCI-FI GOTHIC COLLECTION

URBAN ACCESSORIES

ASSEMBLY INSTRUCTIONS

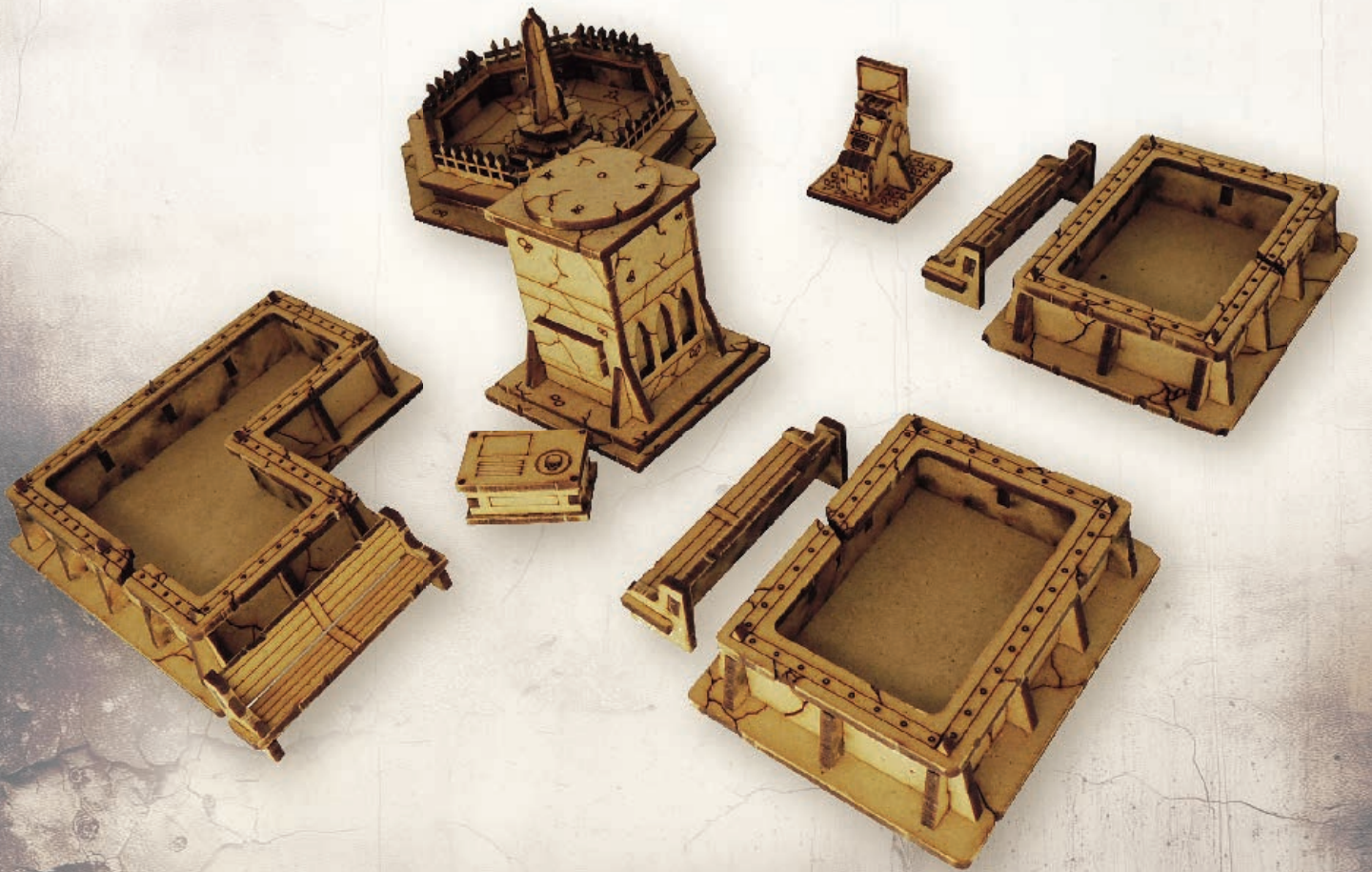

BEFORE ASSEMBLING YOUR KIT, CAREFULLY READ THE FOLLOWING INSTRUCTIONS.

To assemble this kit, you will need several tools:

A modelling knife

Use the modelling knife to detach the pieces from their frame. Do not push them with your fingers or you might break the most fragile parts.

Sandpaper or a small wood file

Sand or file away any rough edges where the parts were attached to the panel.

Wood glue or liquid cyanoacrylate

Glue the pieces according to the assembly plan. Wood glue will take longer to dry than cyanoacrylate glue, but is easier to reposition in case of error.

When assembling this kit, make sure the pieces fit together properly before gluing them together.

You may find some of these icons in the assembly plan. They will provide you with additional information for your assembly.



Indicates the direction of gluing

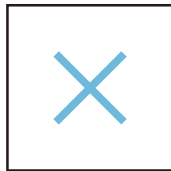

Do not glue

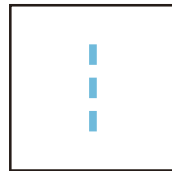

Align



Important note



Construction stage



End of stage



Assembly alternatives

AVANT D'ASSEMBLER VOTRE KIT, LISEZ ATTENTIVEMENT LES INSTRUCTIONS SUIVANTES.

Pour assembler ce kit, vous aurez besoin de plusieurs outils :

Un couteau de modélisme

Utilisez le couteau de modélisme pour détacher les pièces de leur cadre. Ne poussez pas avec vos doigts car vous risqueriez de casser les pièces les plus fragiles.

Du papier abrasif ou une petite lime à bois

Poncez ou limez les aspérités, là où les pièces étaient attachées au panneau.

De la colle à bois ou cyanoacrylate liquide

Collez les pièces suivant le plan de montage. La colle à bois mettra plus de temps à sécher que la colle cyanoacrylate, mais est plus facilement repositionnable en cas d'erreur.

Lorsque vous assemblez ce kit, vérifiez avant de coller si les pièces s'emboîtent correctement.

Vous trouverez peut-être certaines de ces icônes dans le plan de montage. Elles vous fourniront des informations complémentaires pour votre assemblage.



Indique la direction du collage

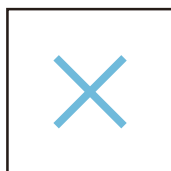

Ne pas coller



Aligner



Remarque importante

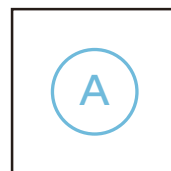

Etape de construction



Fin d'étape



Alternatives de montage

Step 1 B1 + B3 + B4

(A)

B1 B3 B4

Step 2 B2

B2

x3
(A)
✓

Step 1 A9 + A10

(B)

A9 A10 A10

Step 2 A11

A11 x2

Step 3 A12

A12

(B)
✓

Step 1 A13 + A14

(C)

A13 A14

Step 2

A15 + A16

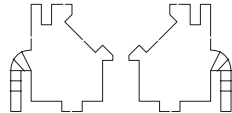
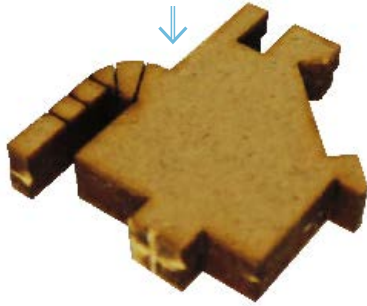

A15

A16

Step 3

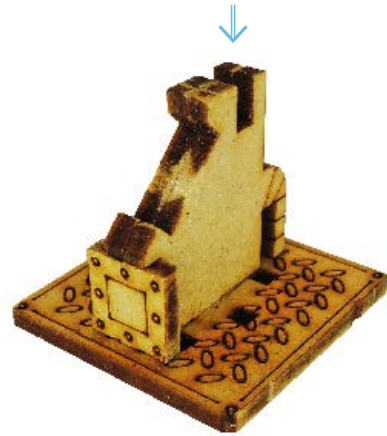

Step 4

A18 + A19

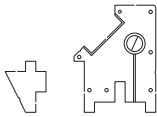
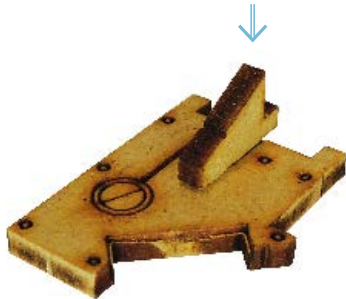

A18

A19

Step 5

A18 + A20

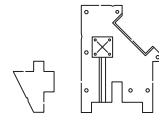
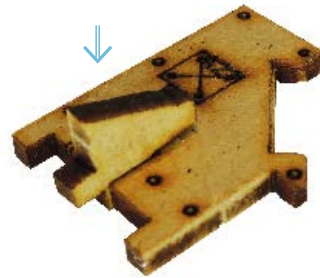

A18

A20

Step 6

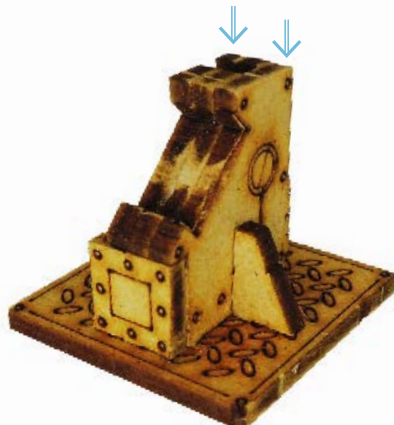

Step 7

A21

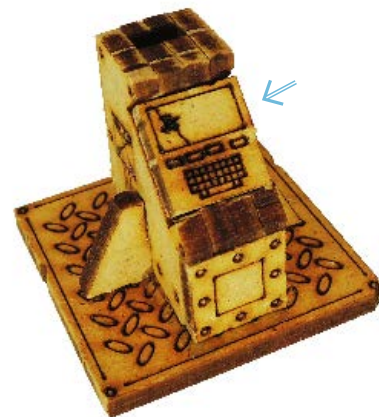

A21

Step 8

A22



A22



Step 1

D1 + D2

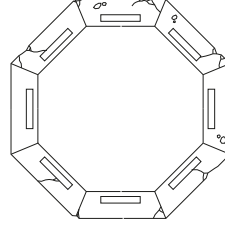
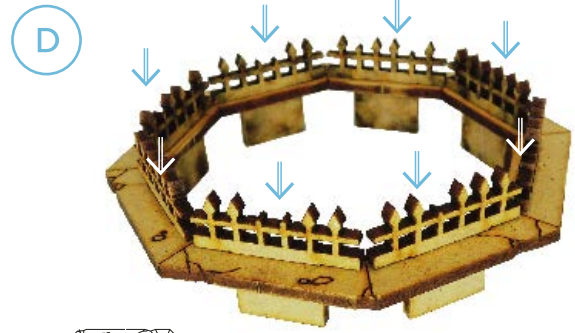

D1

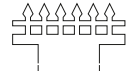

X8

D2

Step 2

D3

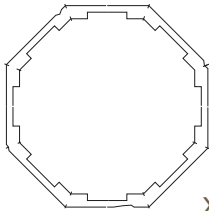

D3

X3

Step 3

C10

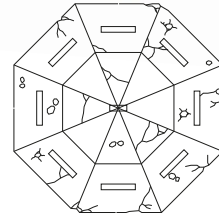
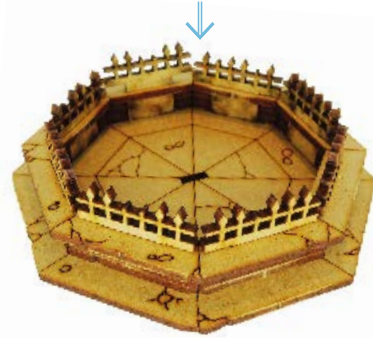

C10

Step 4

C11 + C12

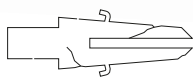

C11

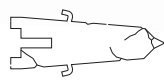

C12

Step 5

C13

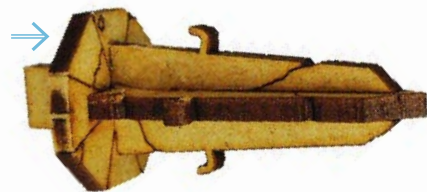

C13

Step 6

C14

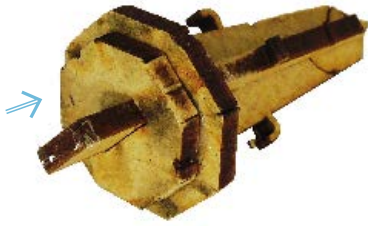

C14

Step 7

C16

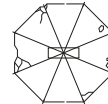
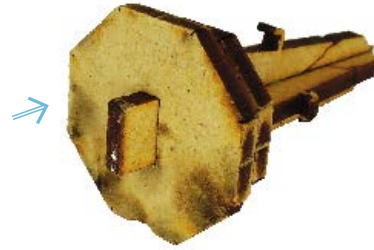

C16

Step 8

C15

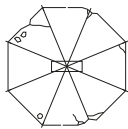
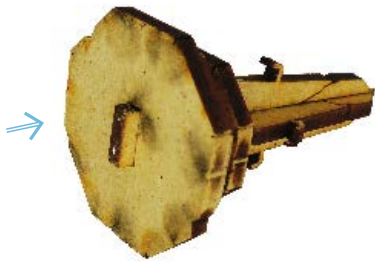

C15

Step 9

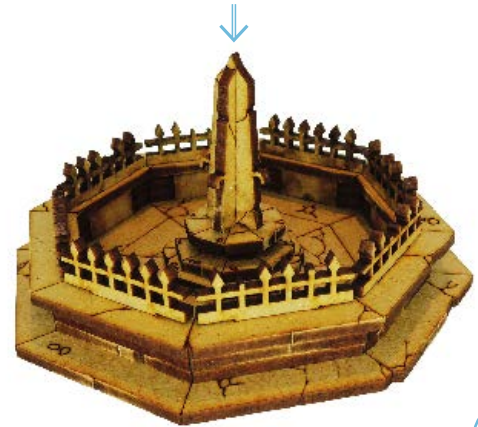

Step 1

A2 + A4

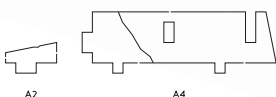
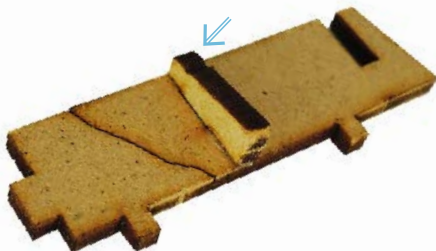

A2

A4

Step 2

A2 + A5

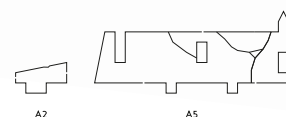
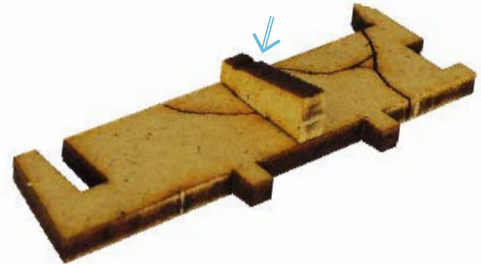

A2

A5

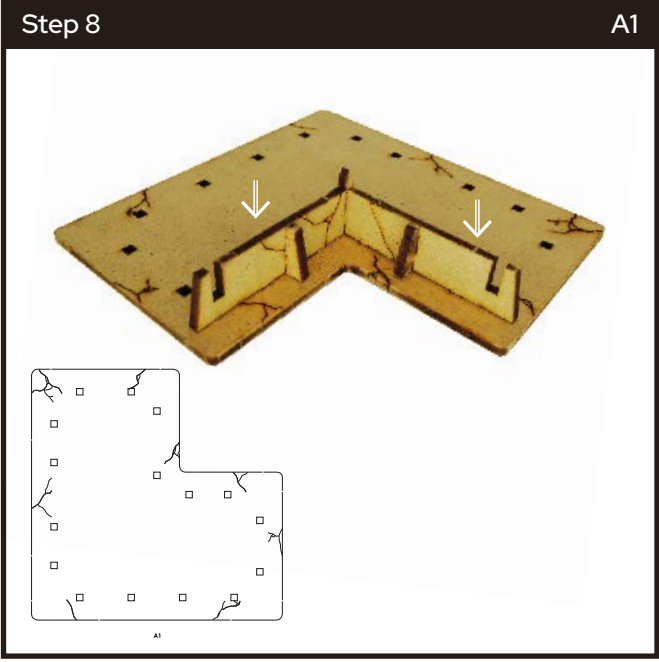
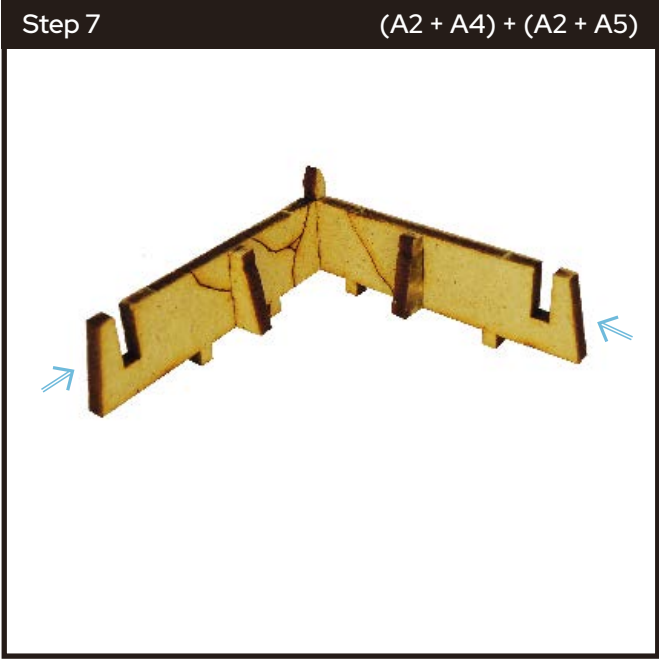
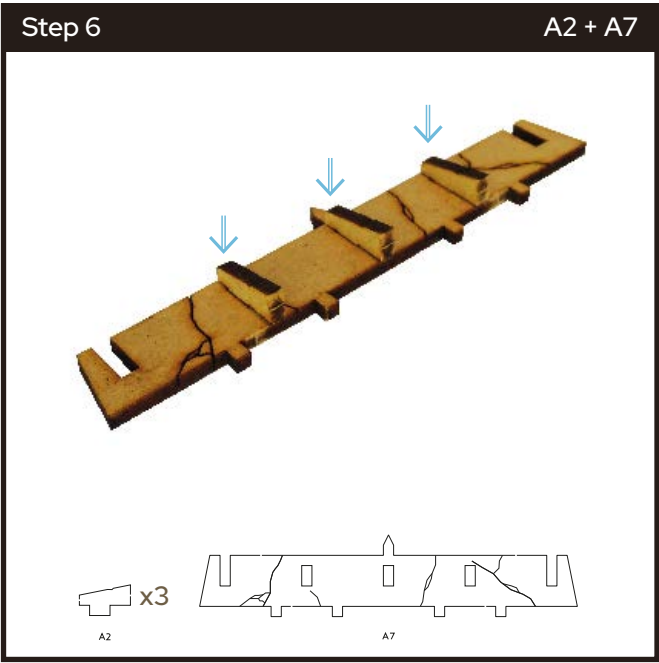
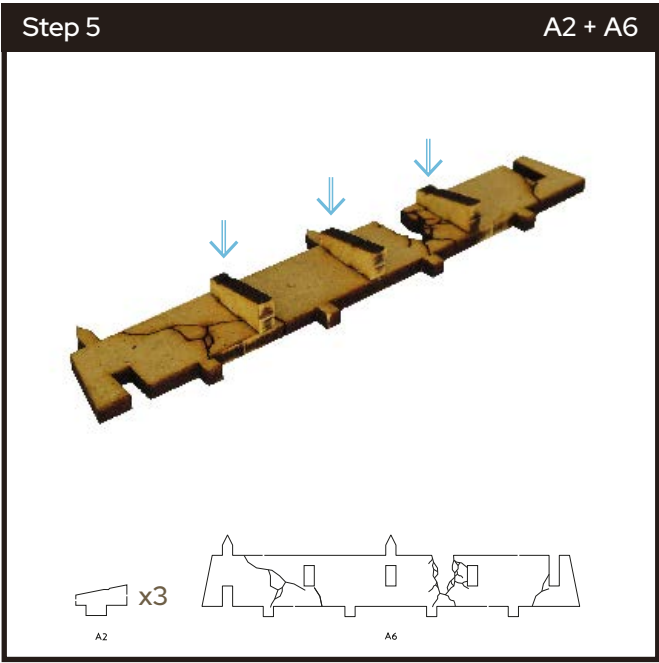
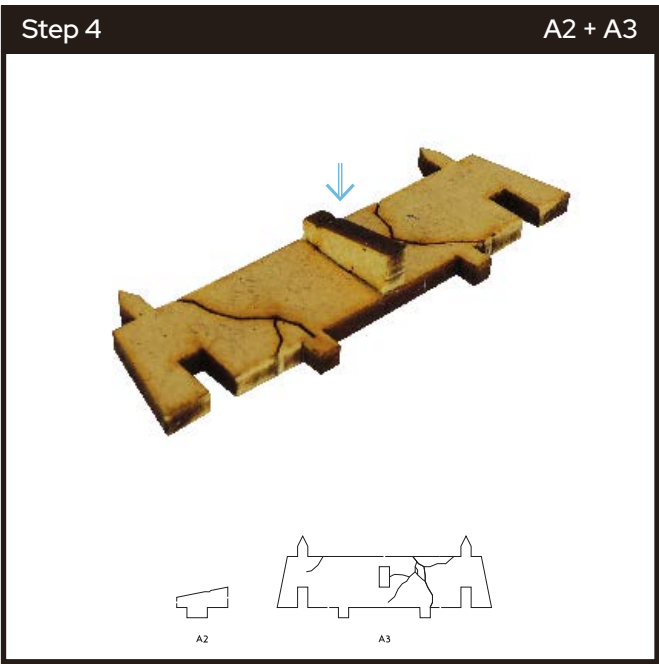
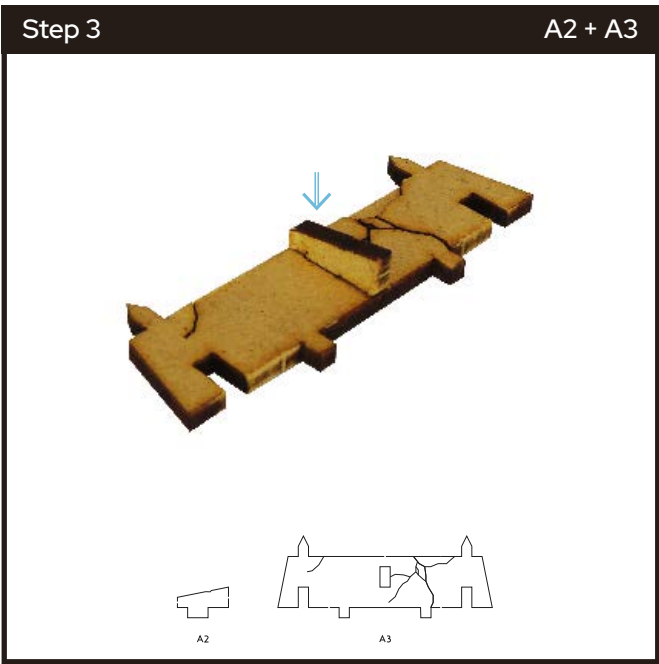

Step 9

(A2 + A7)

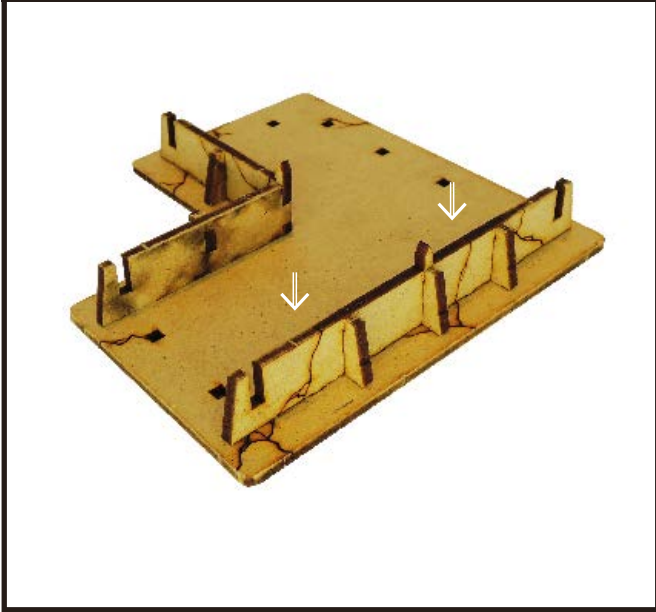

Step 10

(A2 + A6)

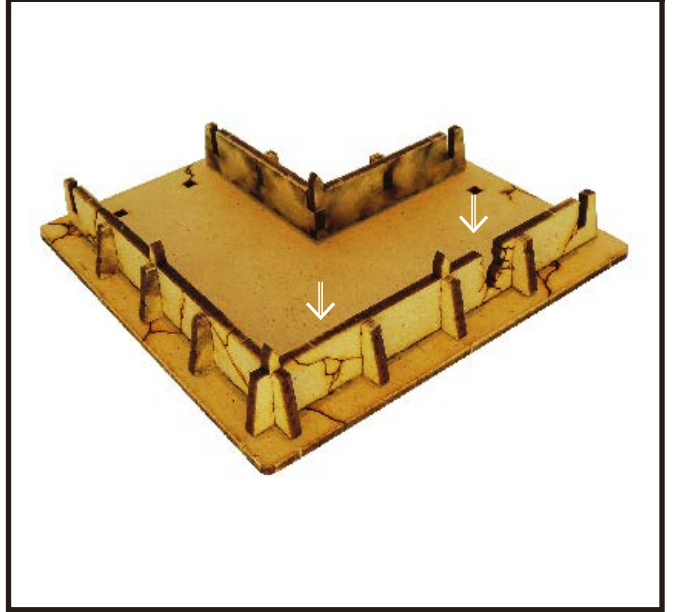

Step 11

(A2 + A3)

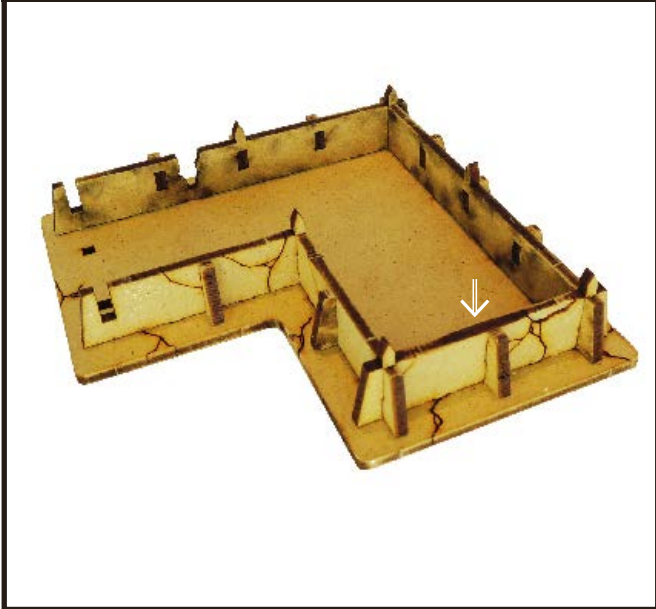

Step 12

(A2 + A3)

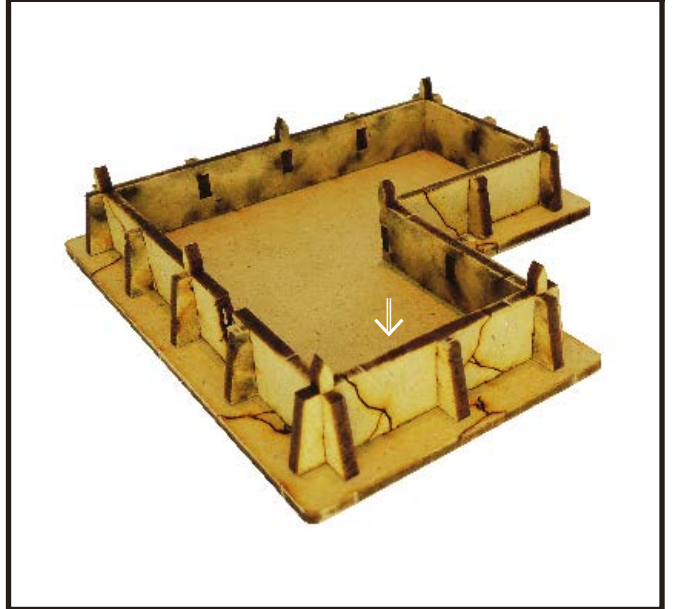

Step 13

A8

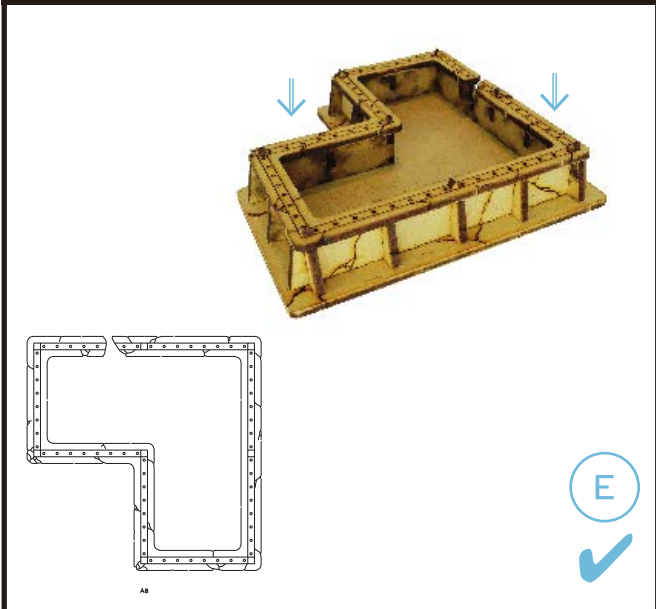

Step 1

B7 + B9

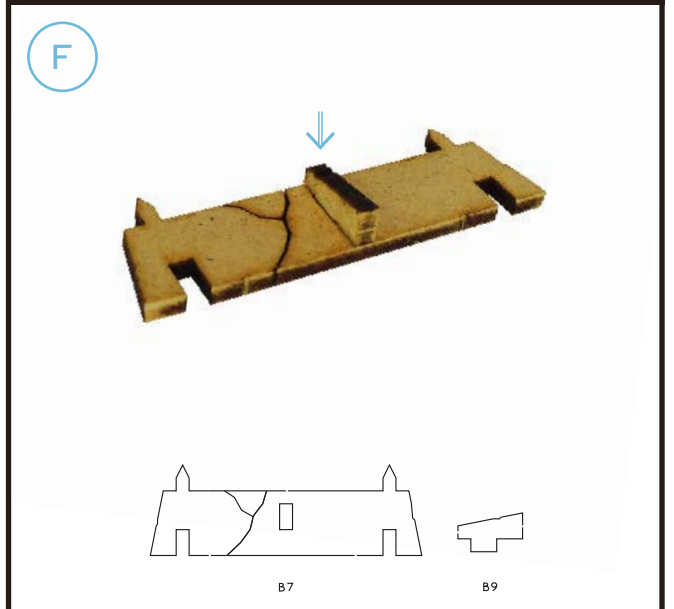

Step 2

B8 + B9

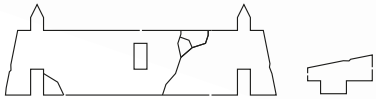
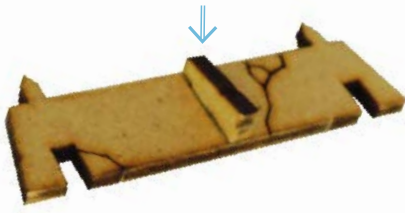

B8

B9

Step 3

B6 + B9

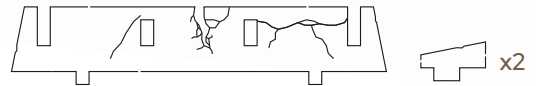
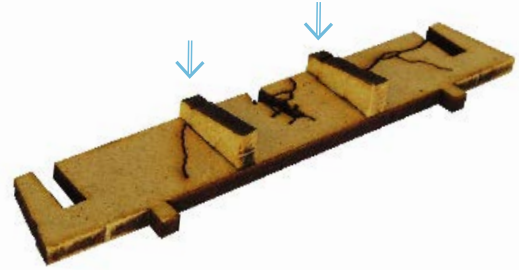

B6

B9

Step 4

B5 + B9

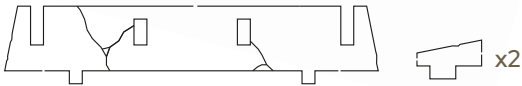
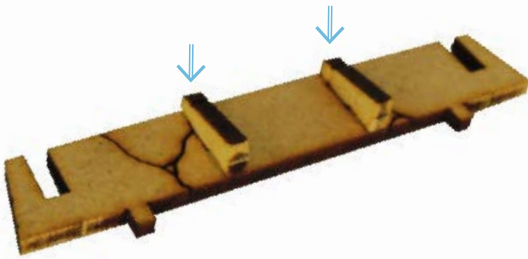

B5

B9

Step 5

(B5 + B9) + (B6 + B9) + B10

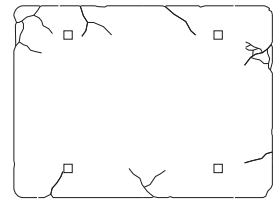
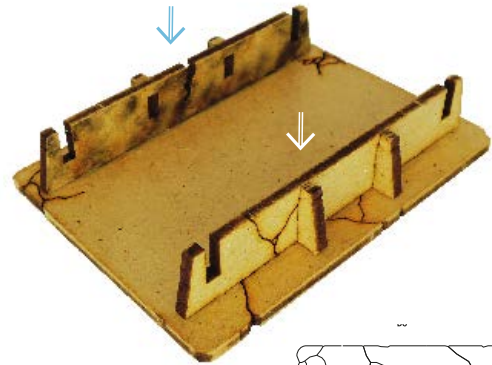

B10

Step 6

(B7 + B9) + (B8 + B9)

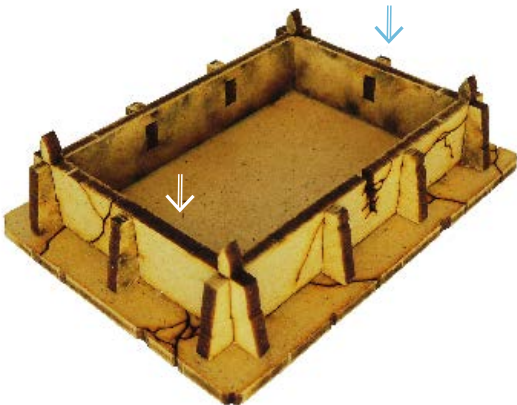

Step 7

B11

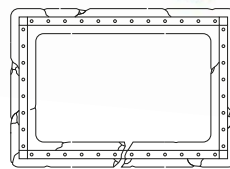

B11

x2



Step 1 C2 + C8

G

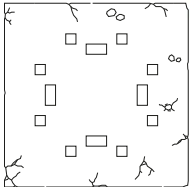
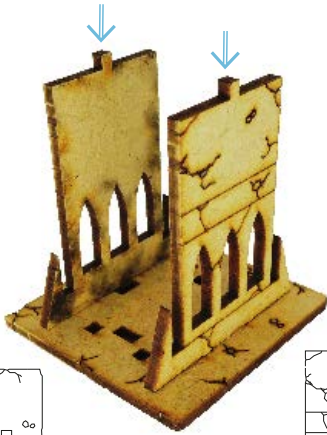

C8

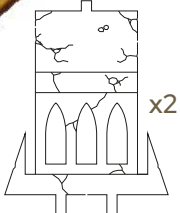

C2

Step 2 C9

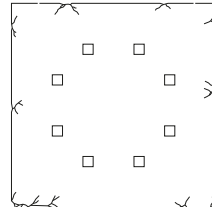

C9

Step 3 C1

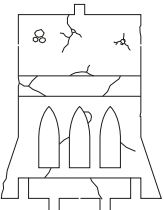

C1

Step 4 C1

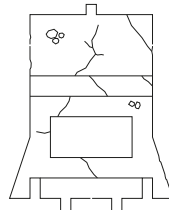
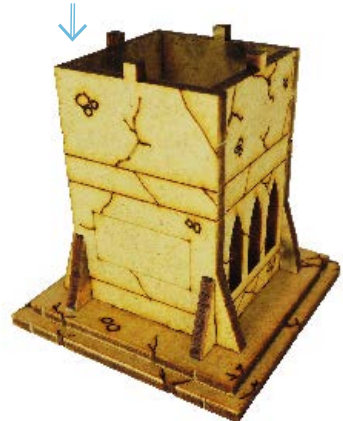

C1

Step 5 C3

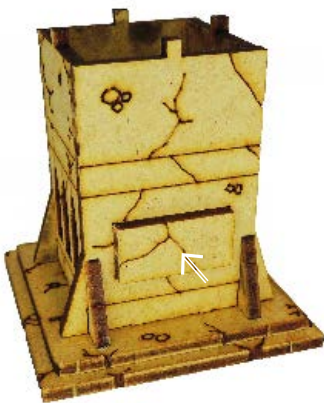

C3

Step 6 C5



C5

Step 7

C4

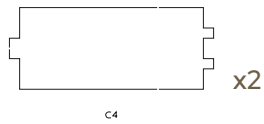

Step 8

C5

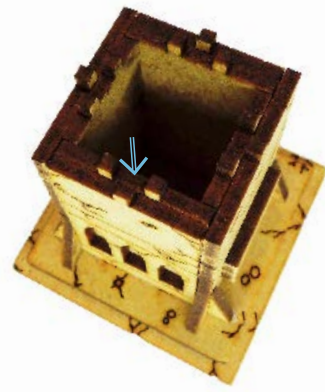

Step 3

C6

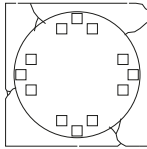

Step 4

C7

