

SCI-FI GOTHIC COLLECTION

GOVERNOR'S PALACE

ASSEMBLY INSTRUCTIONS



dryad-miniworlds.be

SF-030 / © DRYAD MiniWorlds 2025. All rights reserved. 100% made in Belgium.

BEFORE ASSEMBLING YOUR KIT, CAREFULLY READ THE FOLLOWING INSTRUCTIONS.

To assemble this kit, you will need several tools:

A modelling knife

Use the modelling knife to detach the pieces from their frame. Do not push them with your fingers or you might break the most fragile parts.

Sandpaper or a small wood file

Sand or file away any rough edges where the parts were attached to the panel.

Wood glue or liquid cyanoacrylate

Glue the pieces according to the assembly plan. Wood glue will take longer to dry than cyanoacrylate glue, but is easier to reposition in case of error.

When assembling this kit, make sure the pieces fit together properly before gluing them together.

You may find some of these icons in the assembly plan. They will provide you with additional information for your assembly.



Indicates the direction of gluing



Do not glue



Align



Important note



Construction stage



End of stage



Assembly alternatives

AVANT D'ASSEMBLER VOTRE KIT, LISEZ ATTENTIVEMENT LES INSTRUCTIONS SUIVANTES.

Pour assembler ce kit, vous aurez besoin de plusieurs outils :

Un couteau de modélisme

Utilisez le couteau de modélisme pour détacher les pièces de leur cadre. Ne poussez pas avec vos doigts car vous risqueriez de casser les pièces les plus fragiles.

Du papier abrasif ou une petite lime à bois

Poncez ou limez les aspérités, là où les pièces étaient attachées au panneau.

De la colle à bois ou cyanoacrylate liquide

Collez les pièces suivant le plan de montage. La colle à bois mettra plus de temps à sécher que la colle cyanoacrylate, mais est plus facilement repositionnable en cas d'erreur.

Lorsque vous assemblez ce kit, vérifiez avant de coller si les pièces s'emboîtent correctement.

Vous trouverez peut-être certaines de ces icônes dans le plan de montage. Elles vous fourniront des informations complémentaires pour votre assemblage.



Indique la direction du collage

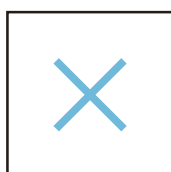

Ne pas coller

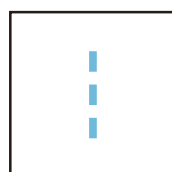

Aligner



Remarque importante

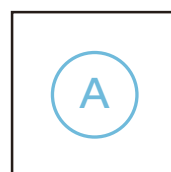

Etape de construction



Fin d'étape



Alternatives de montage

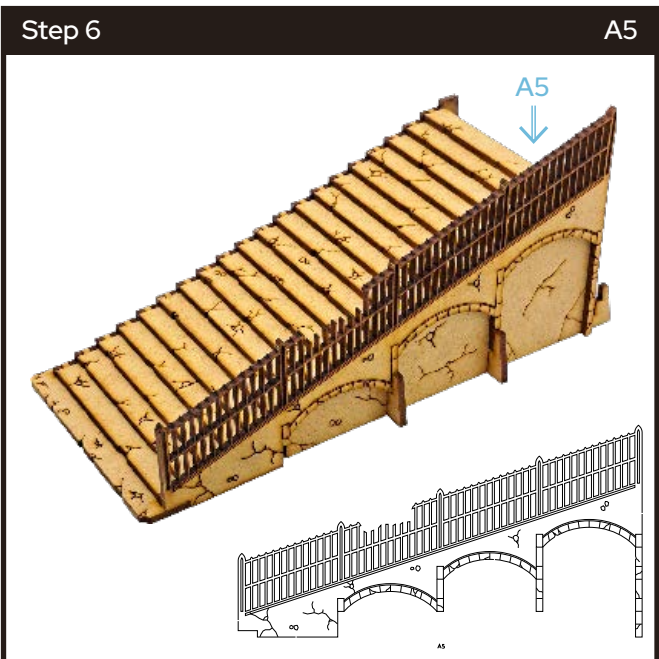
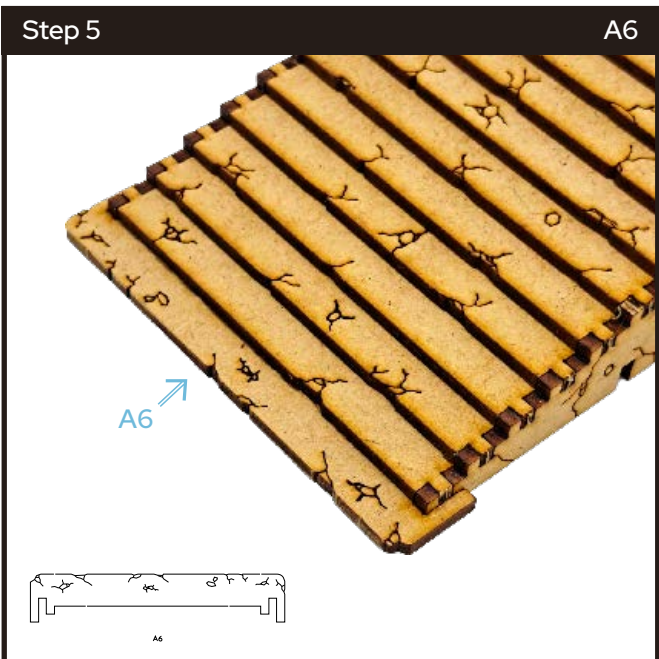
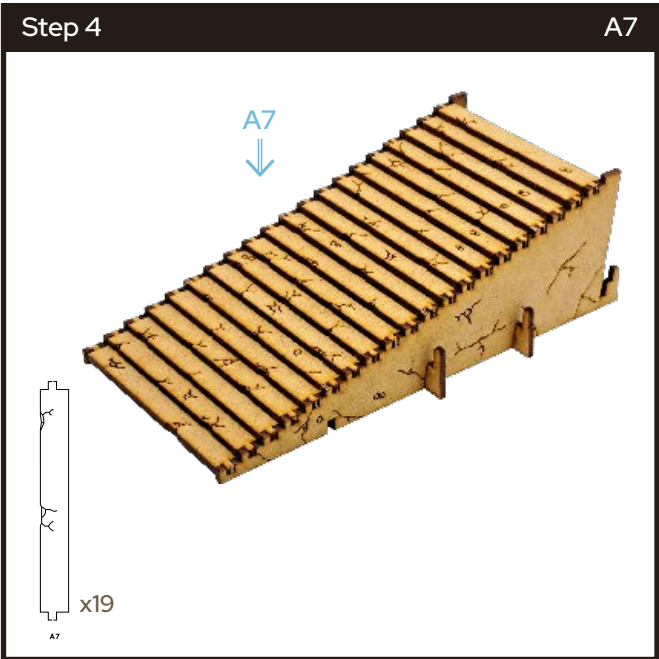
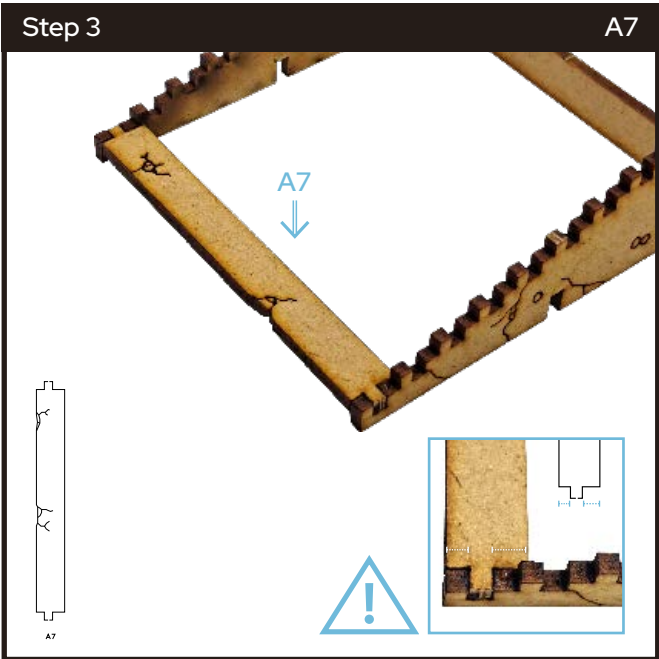
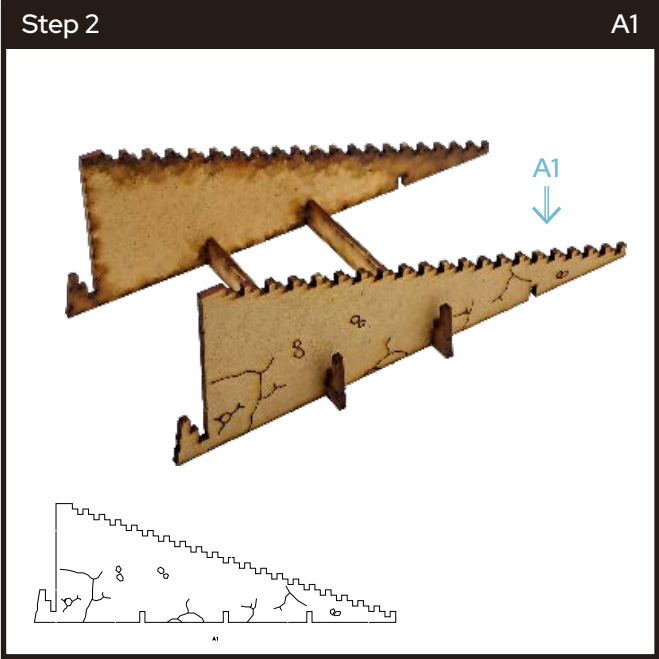
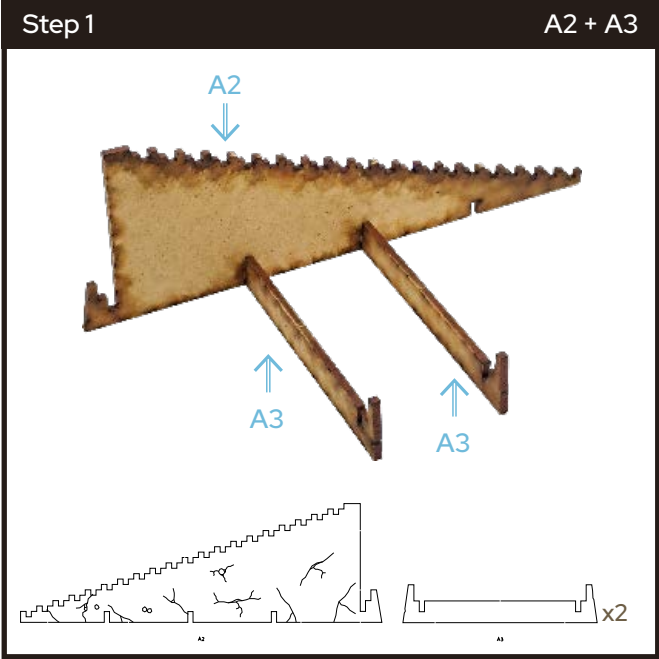

Step 7

A4

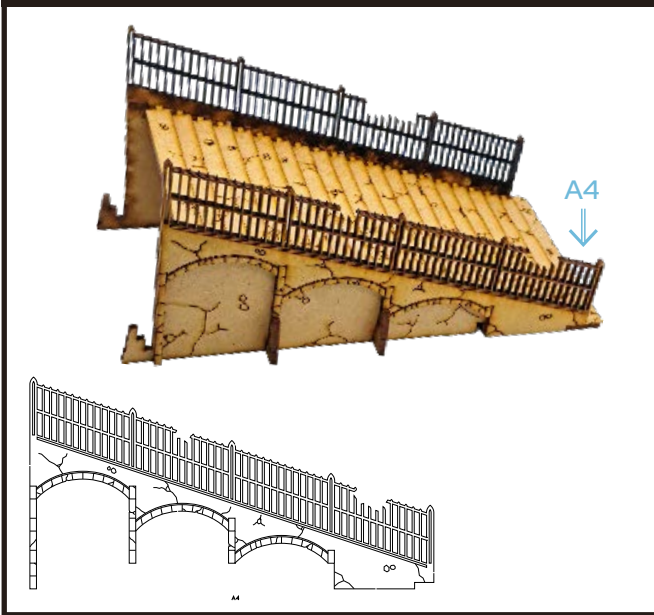

Step 8

B1 + B2

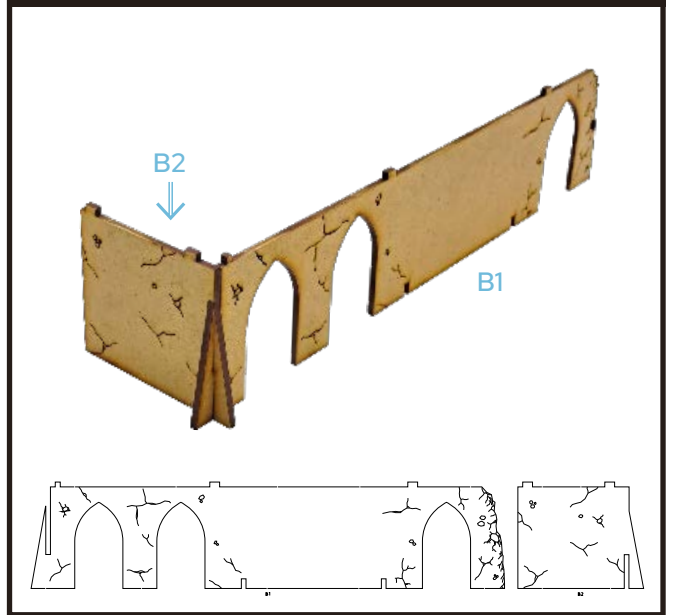

Step 9

A8

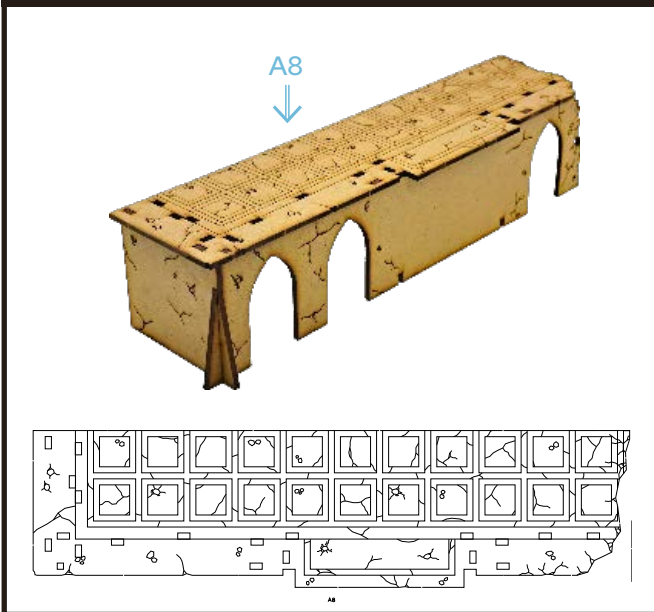

Step 10

B10 + B11

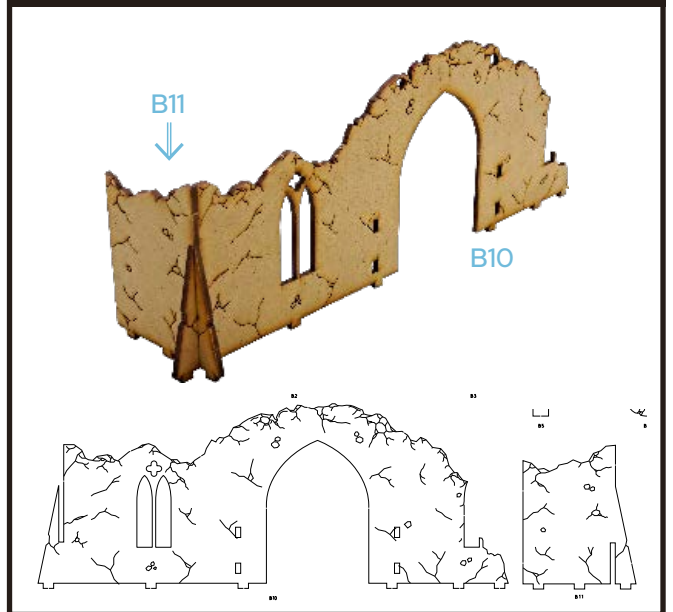

Step 11

C1

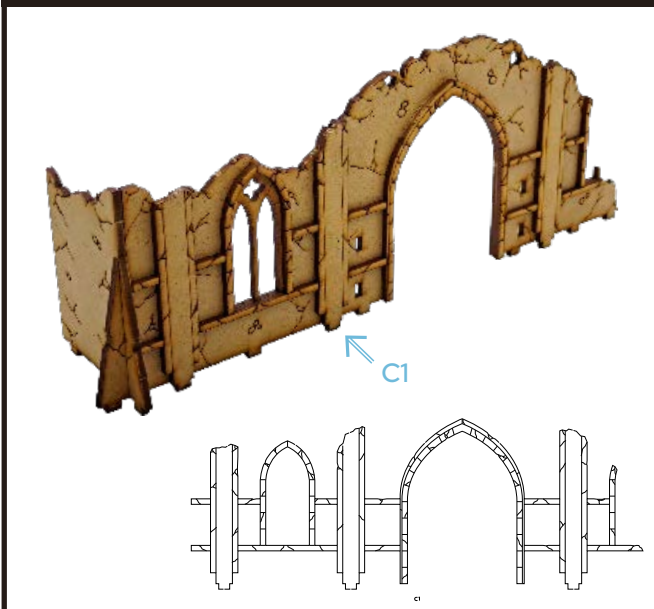

Step 12

A10

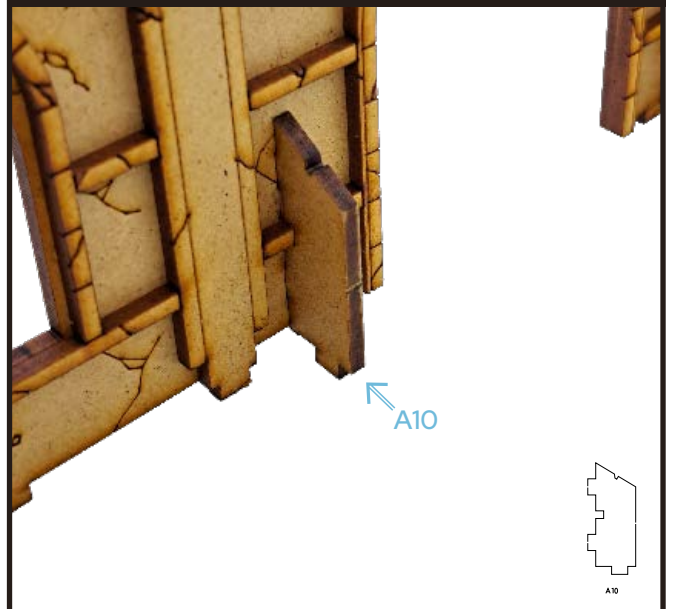

Step 13

A9

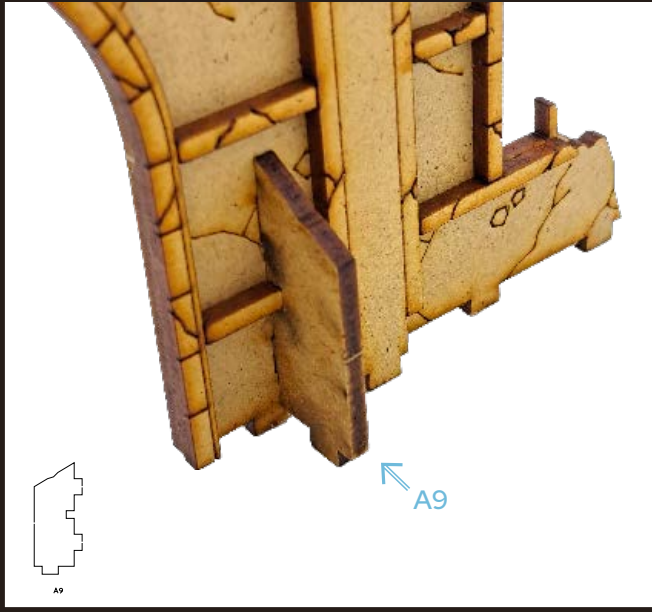

Step 14

Step 9 + Step 13

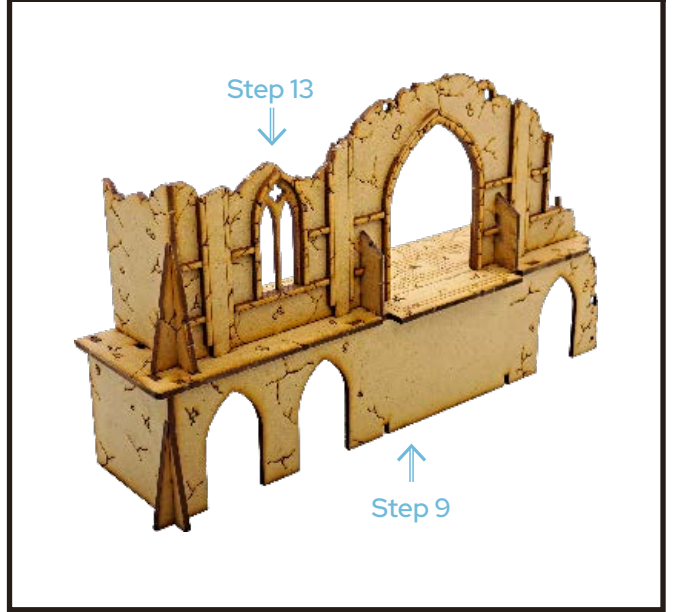

Step 15

B12

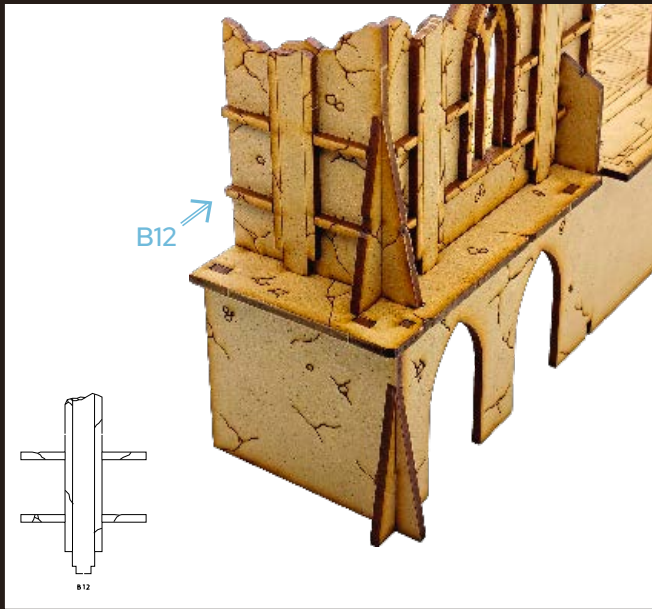

Step 16

B5

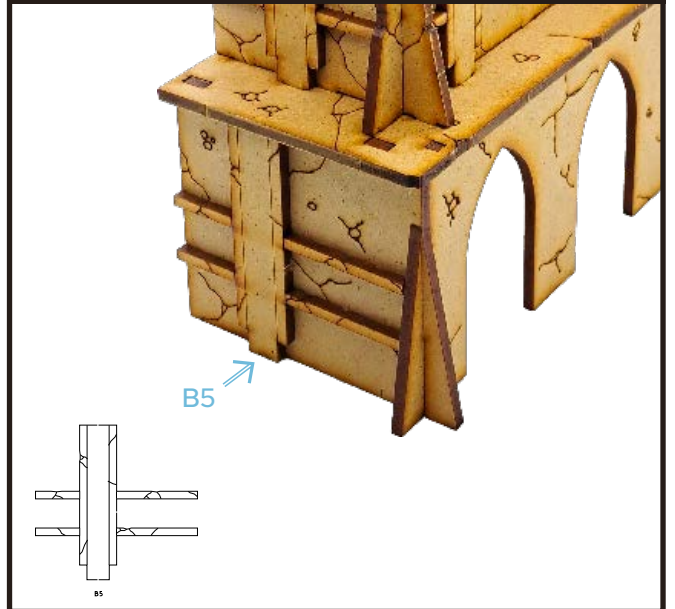

Step 17

B6



Step 18

B7

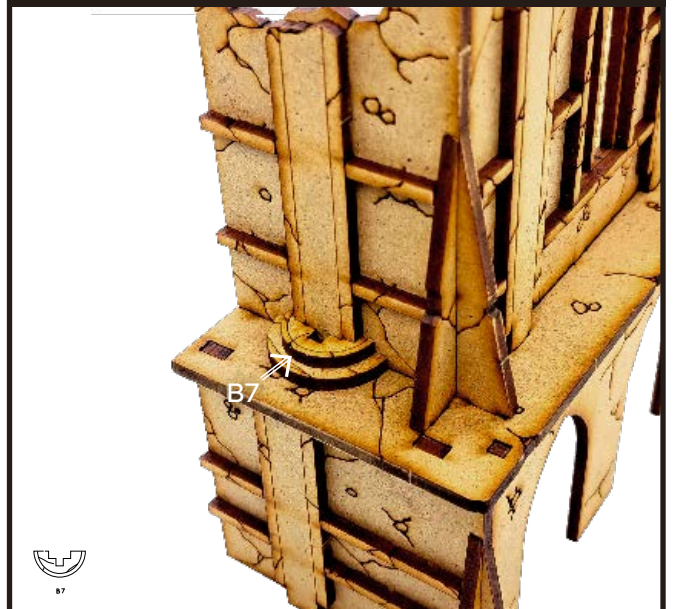

Step 19

B13

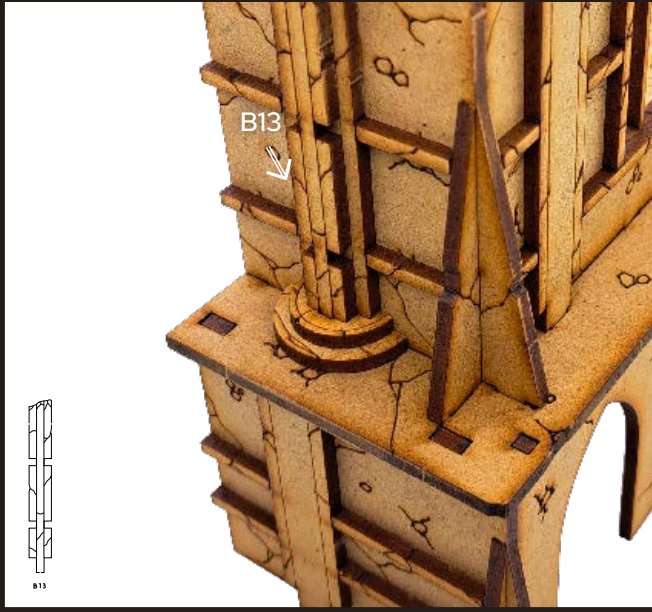

Step 20

B9

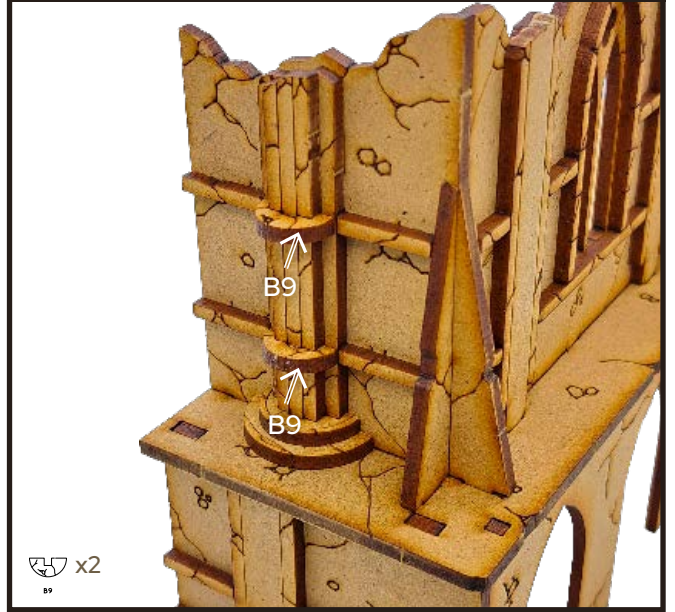

Step 21

B6 + B7

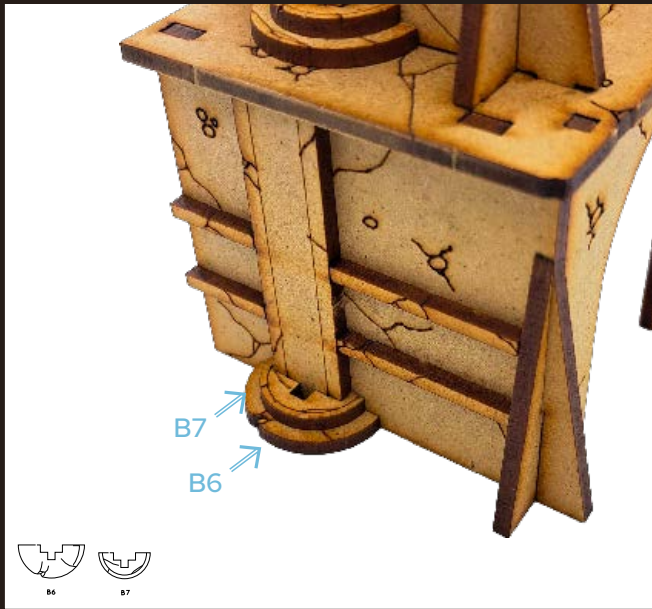

Step 22

B8 + B9



Step 23

C2 + C3

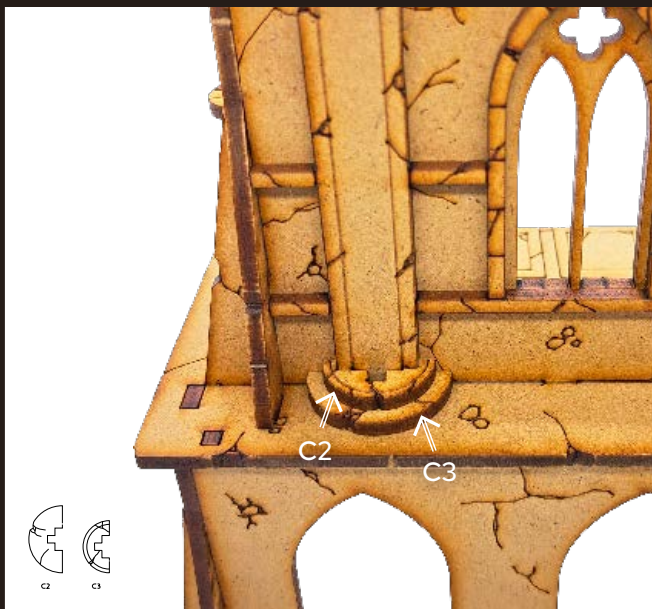

Step 24

C4



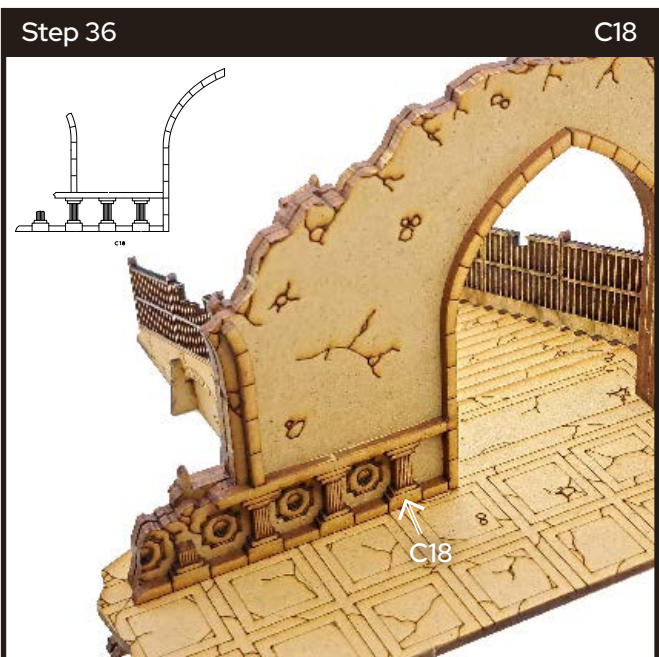
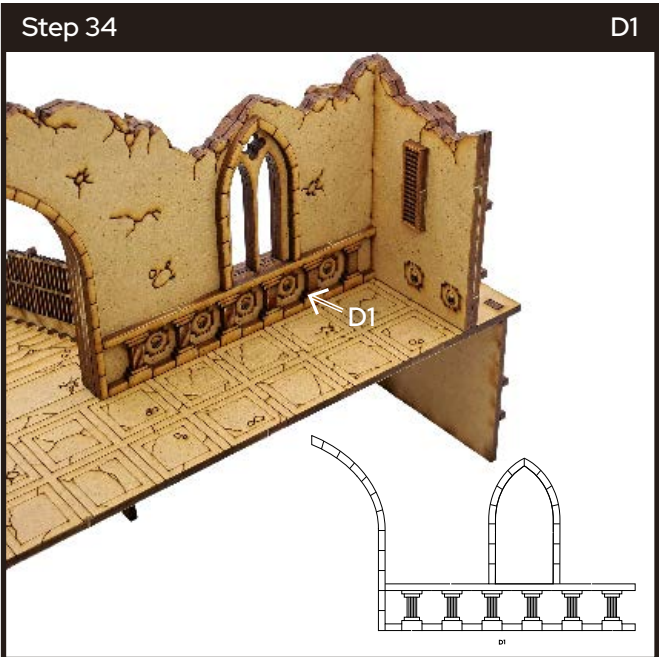
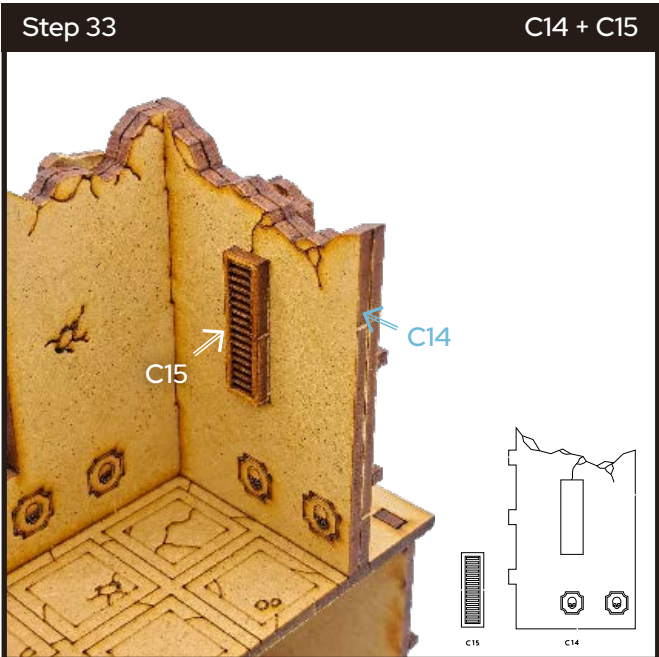
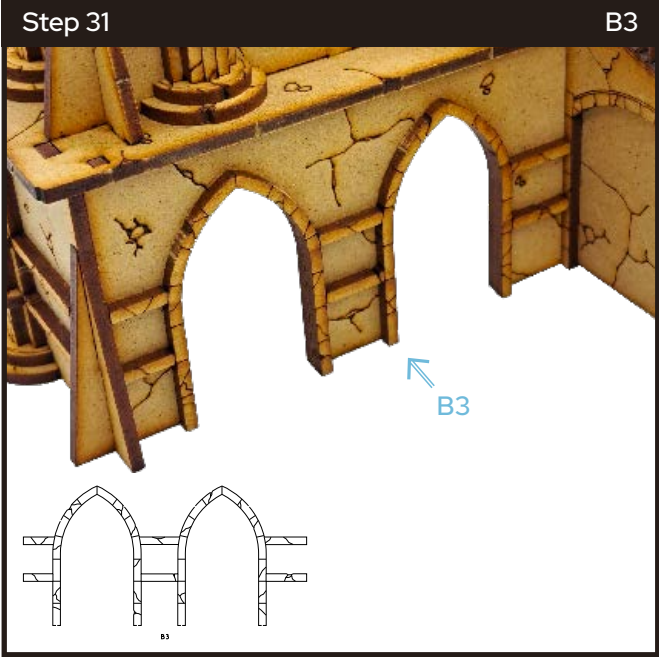

Step 37

C8

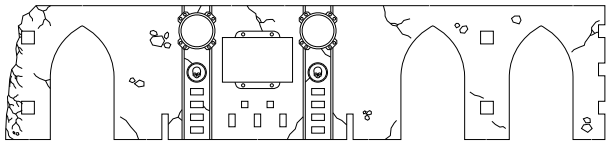
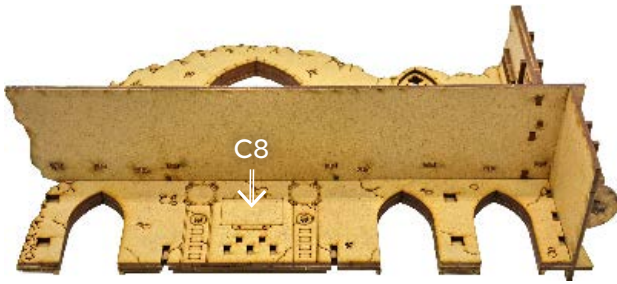

Step 38

C13

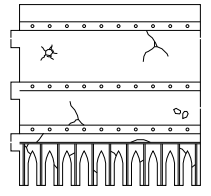
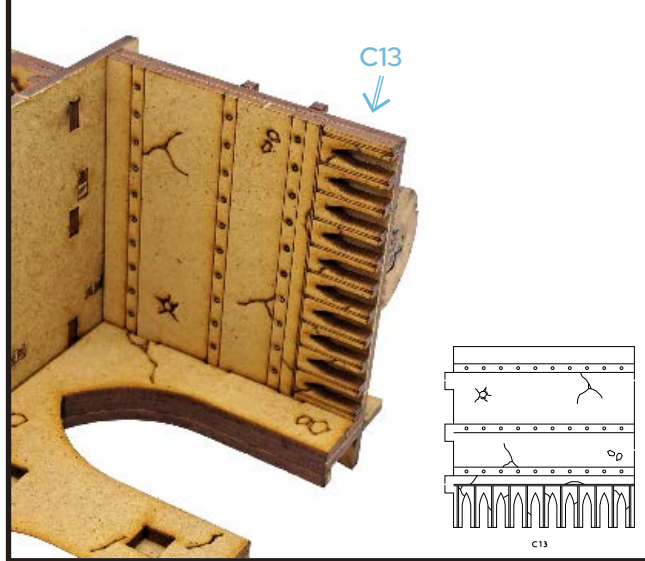

Step 39

B14 + B15

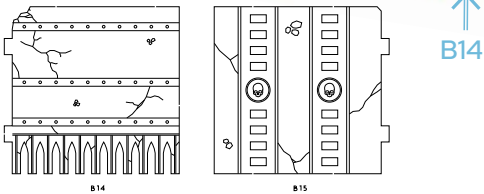

Step 40

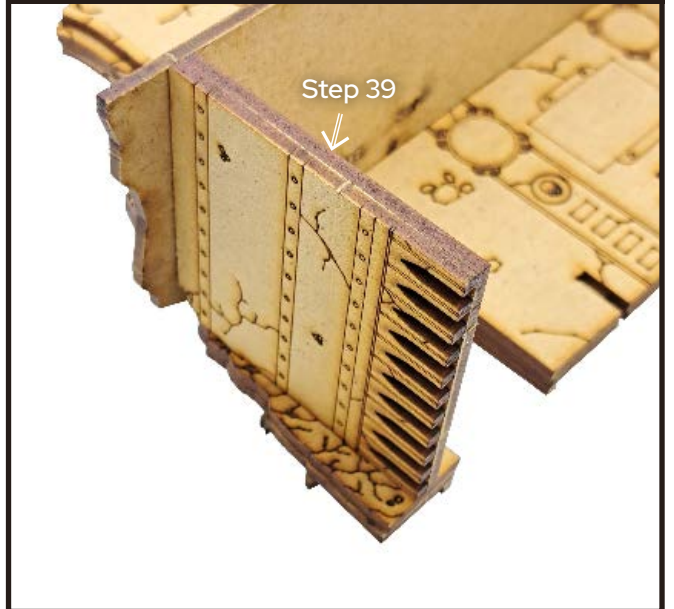

Step 41

B16 + B17

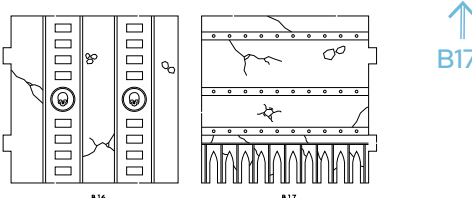
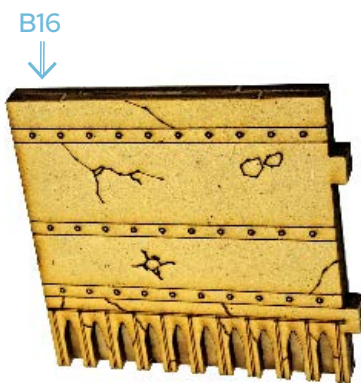

Step 42

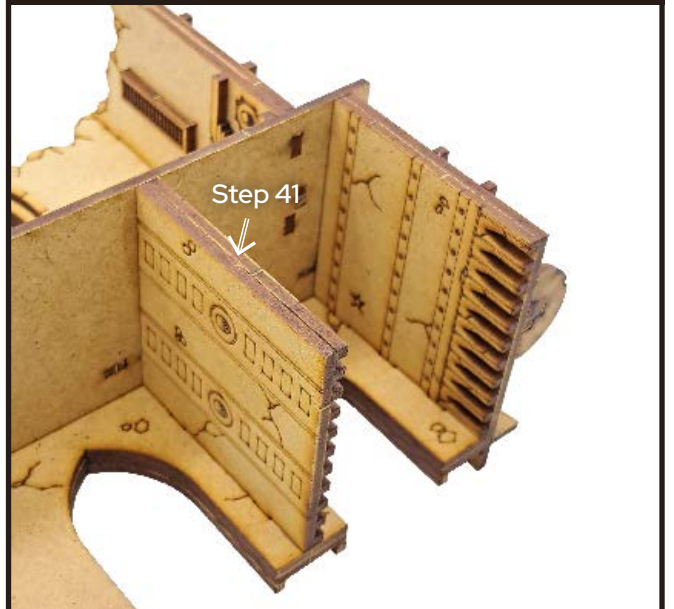

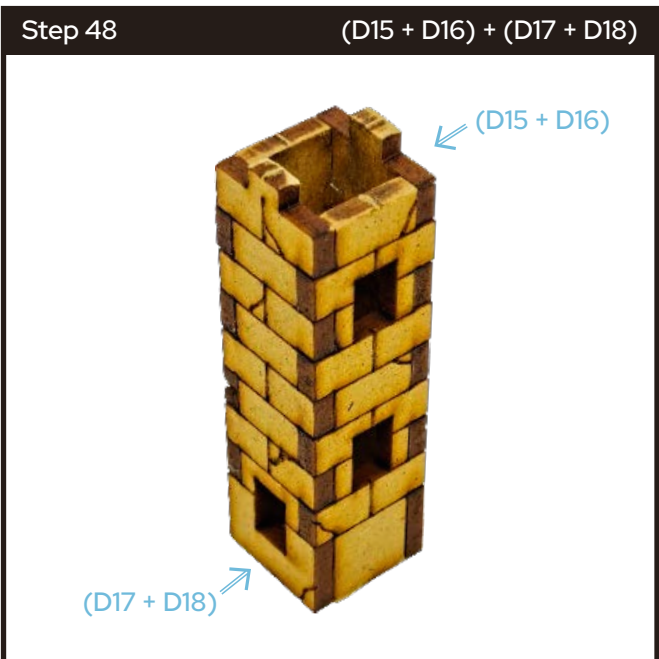
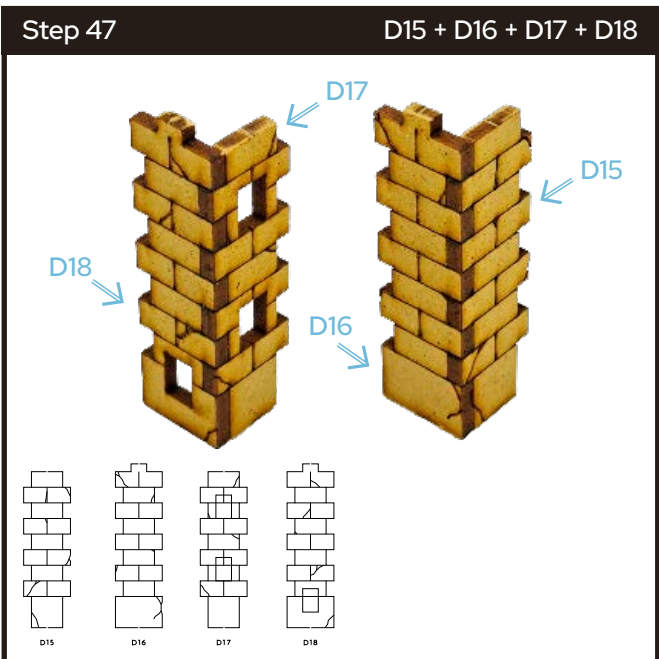
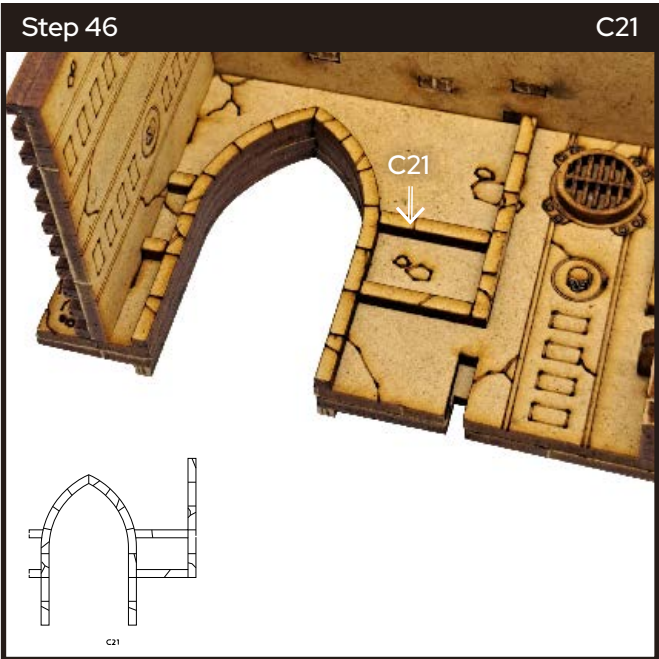
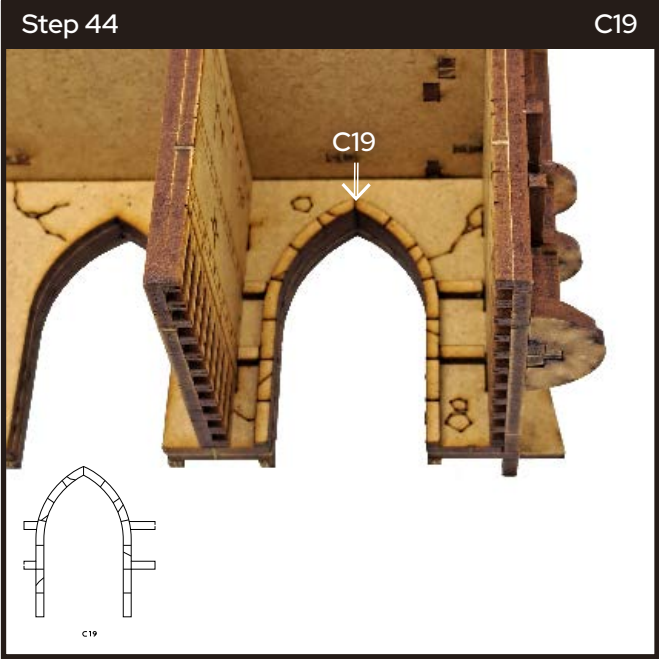

Step 49

D19



Step 50

D20



Step 51

D21

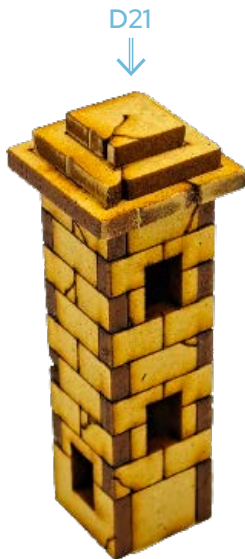

Step 52

D2 + D3 + Step 51

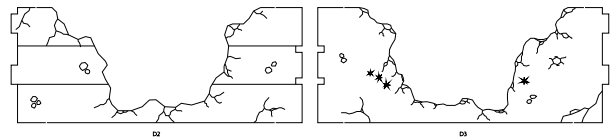
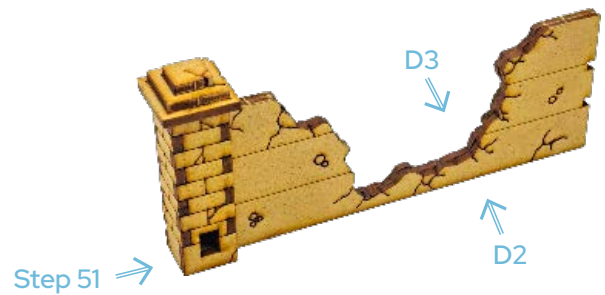

Step 53

D13 + D14

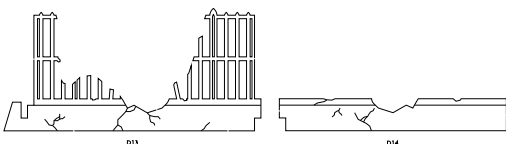
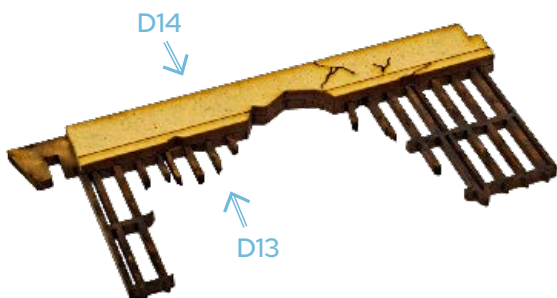

Step 54

Step 52 + Step 53

