

MEDIEVAL FANTASY COLLECTION

# RUINED TEMPLE

ASSEMBLY INSTRUCTIONS



## **BEFORE ASSEMBLING YOUR KIT, CAREFULLY READ THE FOLLOWING INSTRUCTIONS.**

To assemble this kit, you will need several tools:

### **A modelling knife**

Use the modelling knife to detach the pieces from their frame. Do not push them with your fingers or you might break the most fragile parts.

### **Sandpaper or a small wood file**

Sand or file away any rough edges where the parts were attached to the panel.

### **Wood glue or liquid cyanoacrylate**

Glue the pieces according to the assembly plan. Wood glue will take longer to dry than cyanoacrylate glue, but is easier to reposition in case of error.

When assembling this kit, make sure the pieces fit together properly before gluing them together.

You may find some of these icons in the assembly plan.  
They will provide you with additional information for your assembly.



Indicates  
the direction  
of gluing



Do not glue



Align



Important  
note



Construction  
stage



End  
of stage



Assembly  
alternatives

## **AVANT D'ASSEMBLER VOTRE KIT, LISEZ ATTENTIVEMENT LES INSTRUCTIONS SUIVANTES.**

Pour assembler ce kit, vous aurez besoin de plusieurs outils :

### **Un couteau de modélisme**

Utilisez le couteau de modélisme pour détacher les pièces de leur cadre. Ne poussez pas avec vos doigts car vous risqueriez de casser les pièces les plus fragiles.

### **Du papier abrasif ou une petite lime à bois**

Poncez ou limez les aspérités, là où les pièces étaient attachées au panneau.

### **De la colle à bois ou cyanoacrylate liquide**

Collez les pièces suivant le plan de montage. La colle à bois mettra plus de temps à sécher que la colle cyanoacrylate, mais est plus facilement repositionnable en cas d'erreur.

Lorsque vous assemblez ce kit, vérifiez avant de coller si les pièces s'emboîtent correctement.

Vous trouverez peut-être certaines de ces icônes dans le plan de montage.  
Elles vous fourniront des informations complémentaires pour votre assemblage.



Indique  
la direction  
du collage

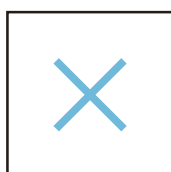

Ne pas  
coller

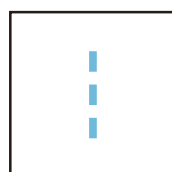

Aligner



Remarque  
importante

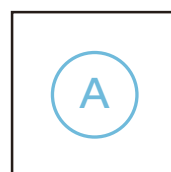

Etape de  
construction



Fin  
d'étape



Alternatives de  
montage

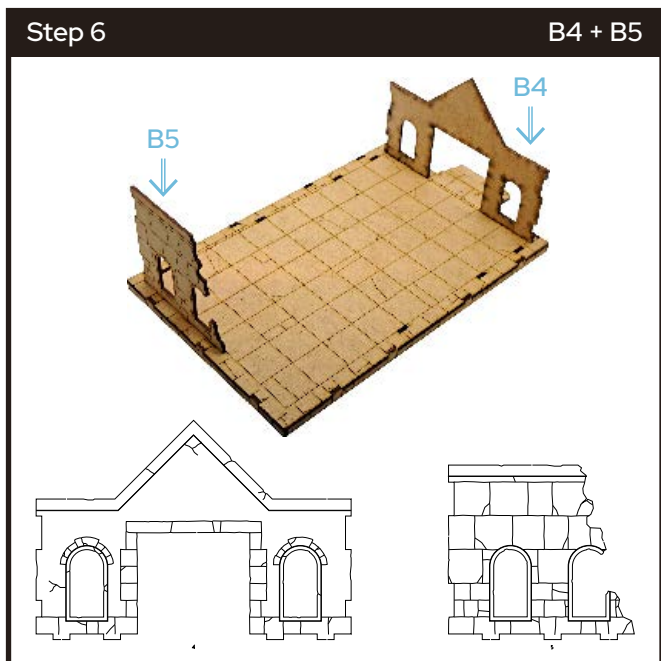
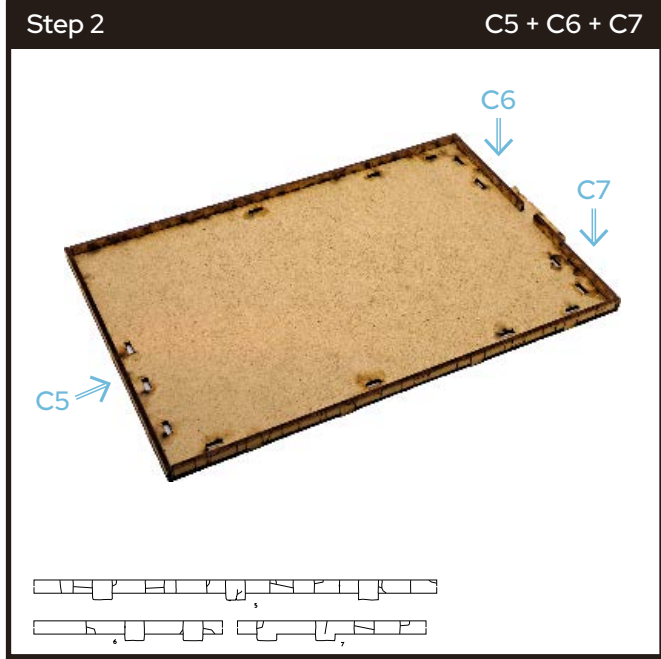
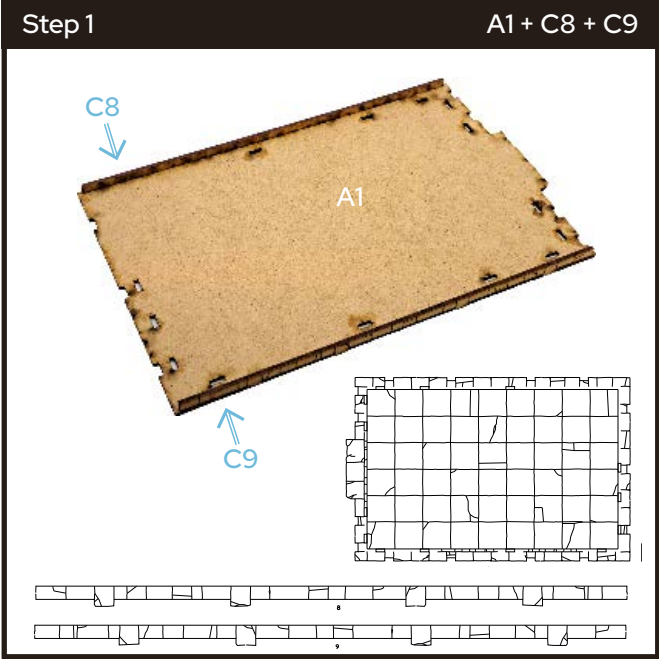

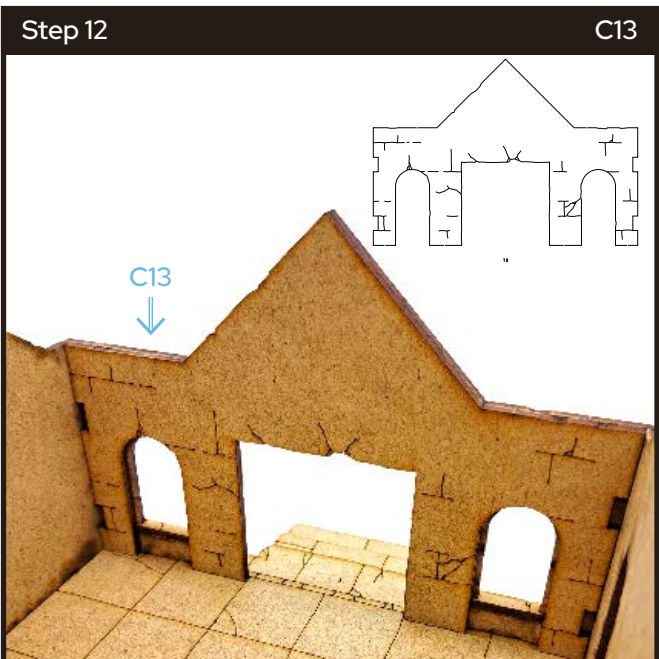
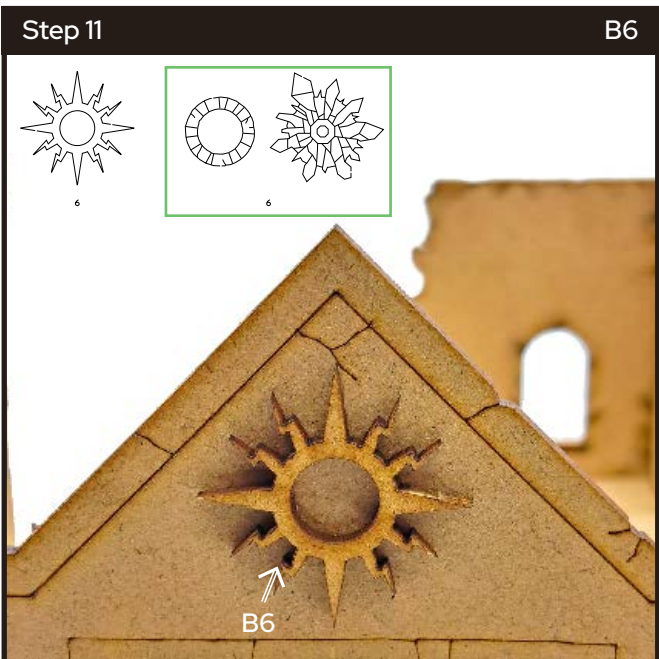
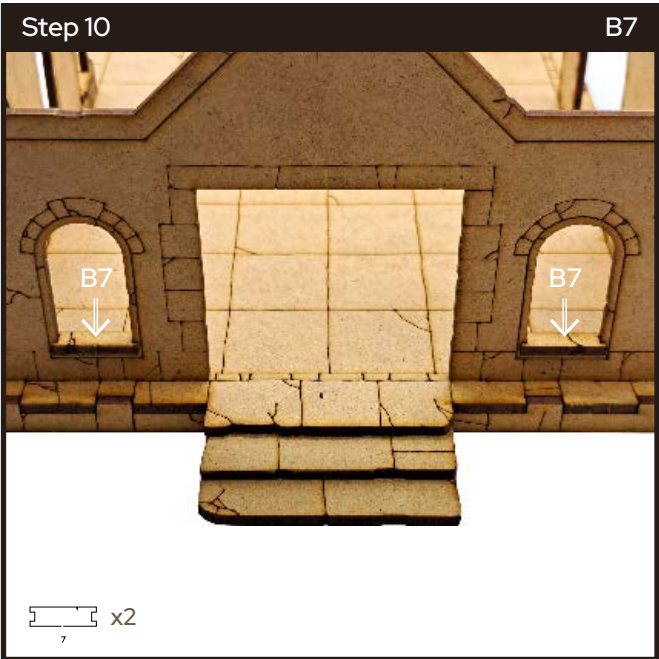
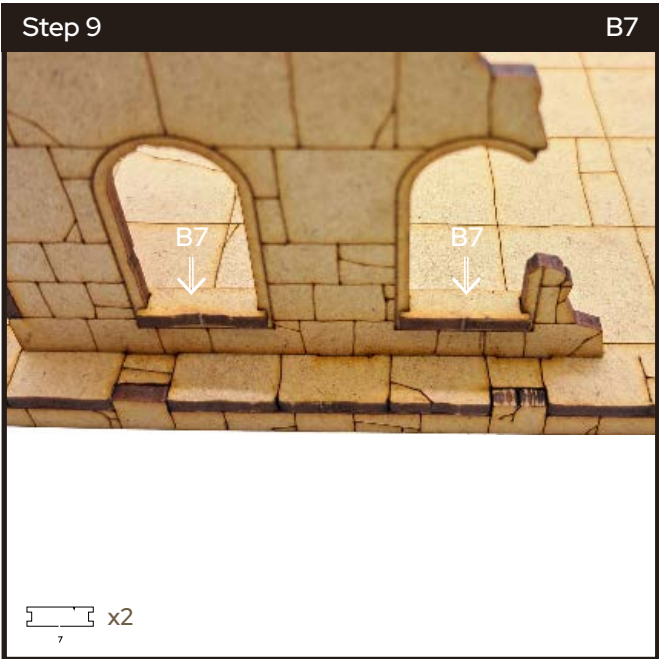
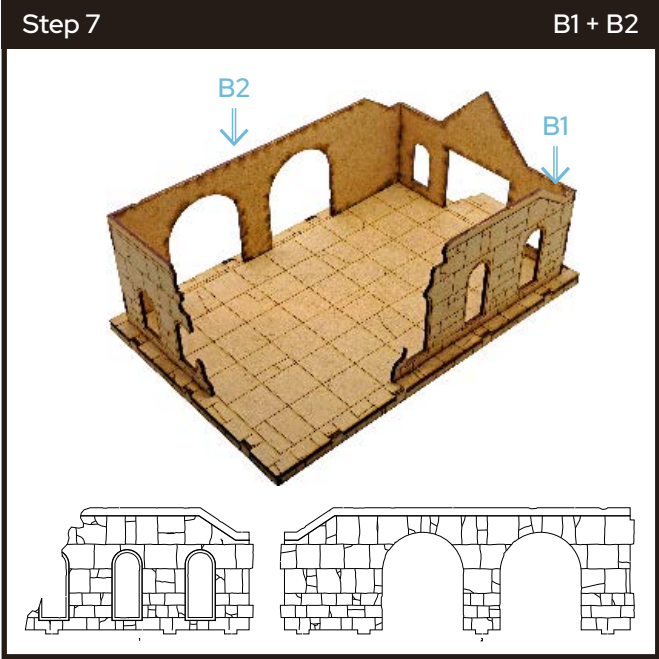

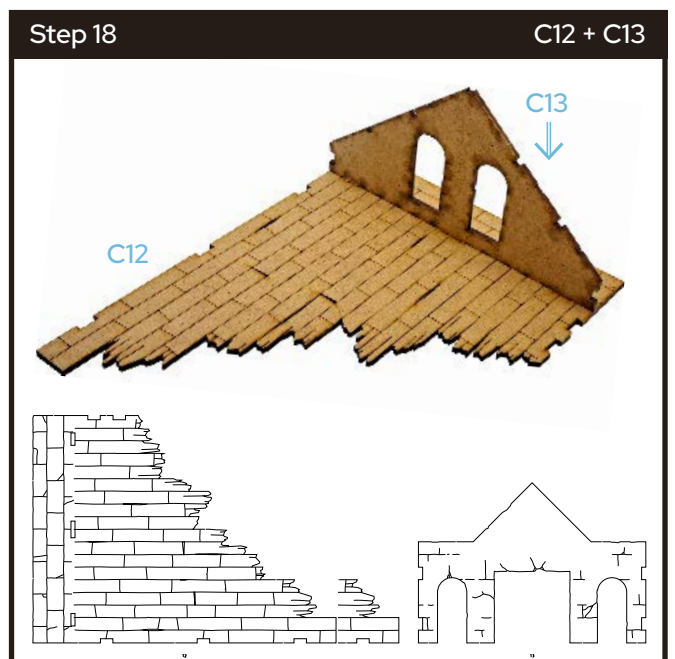
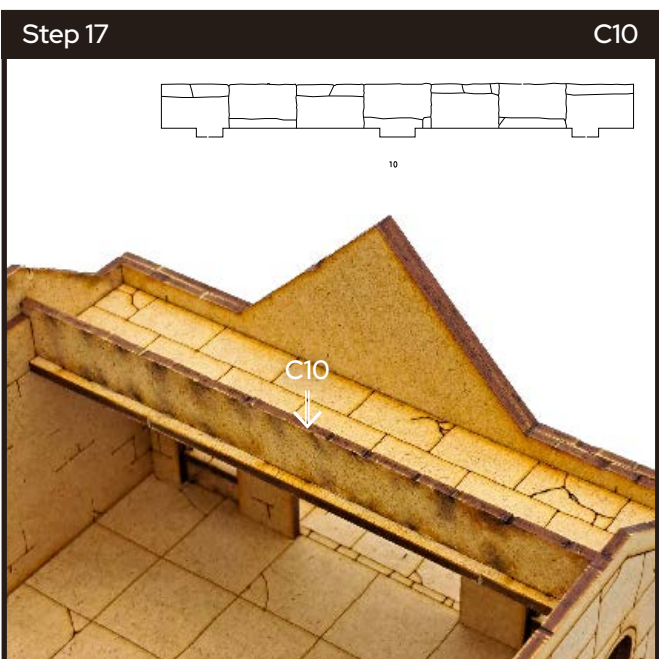
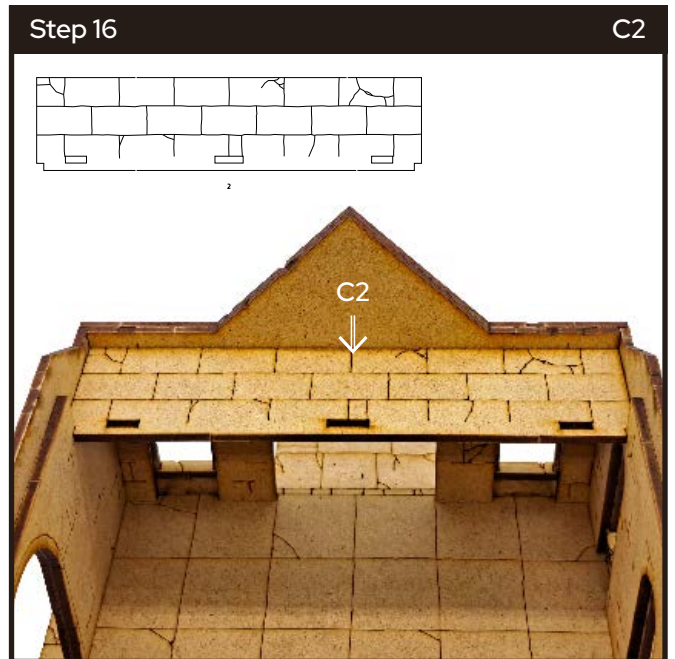
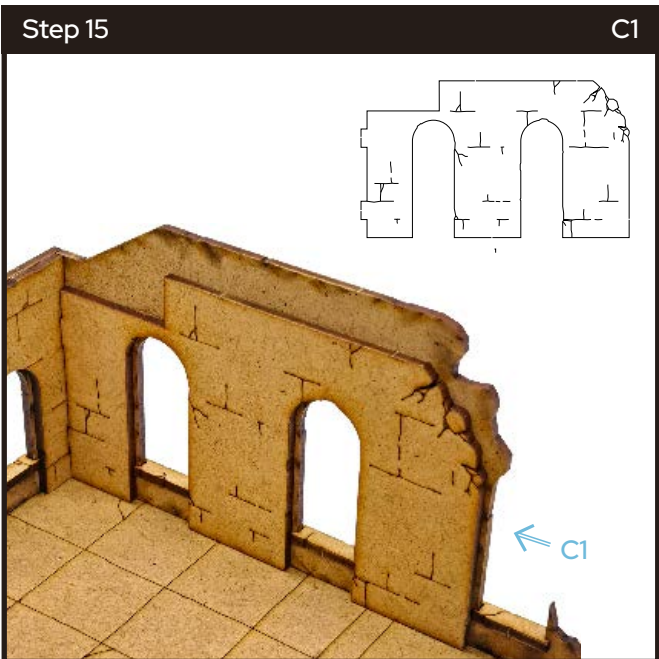
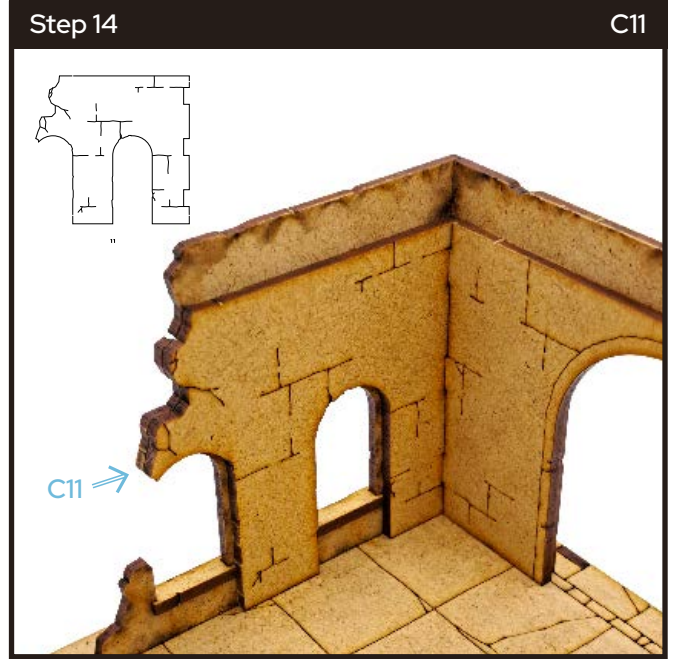
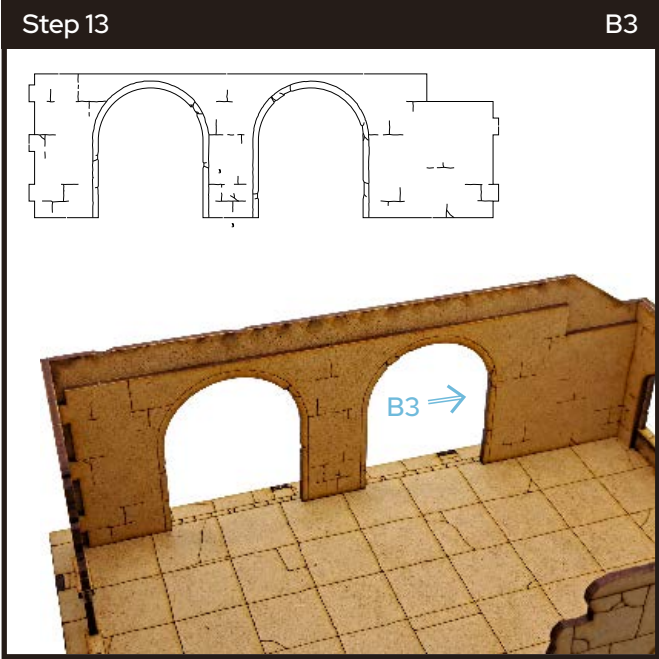

Step 19 A6 + A7

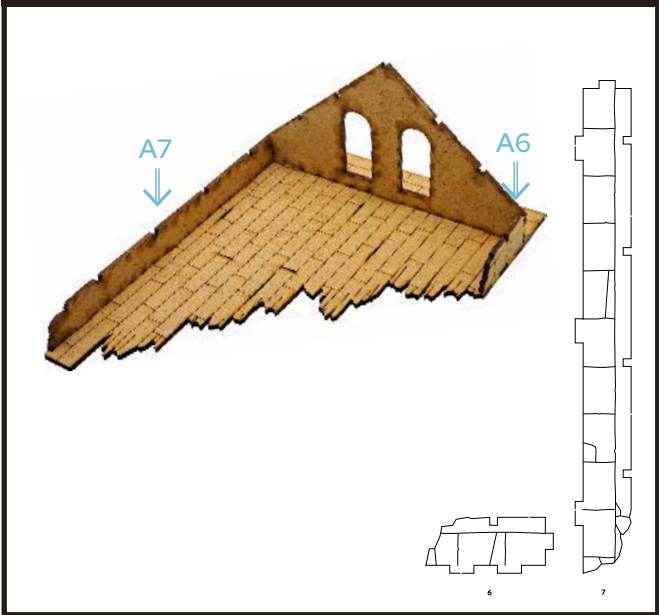

Step 20 A2

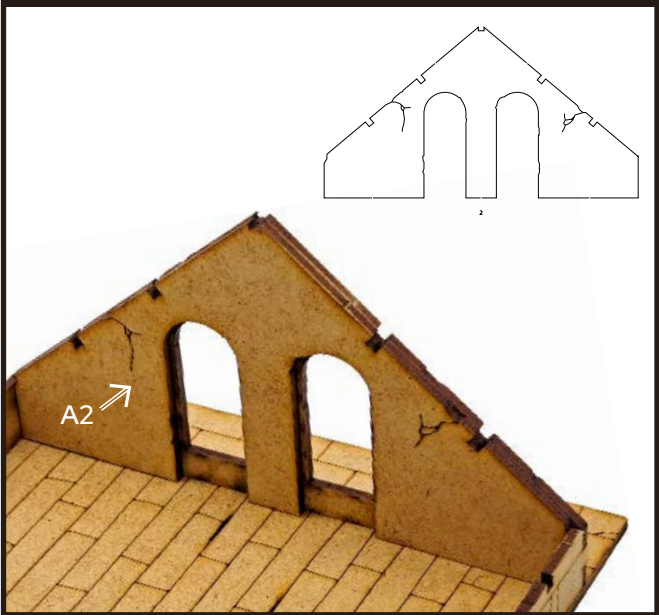

Step 21 A11

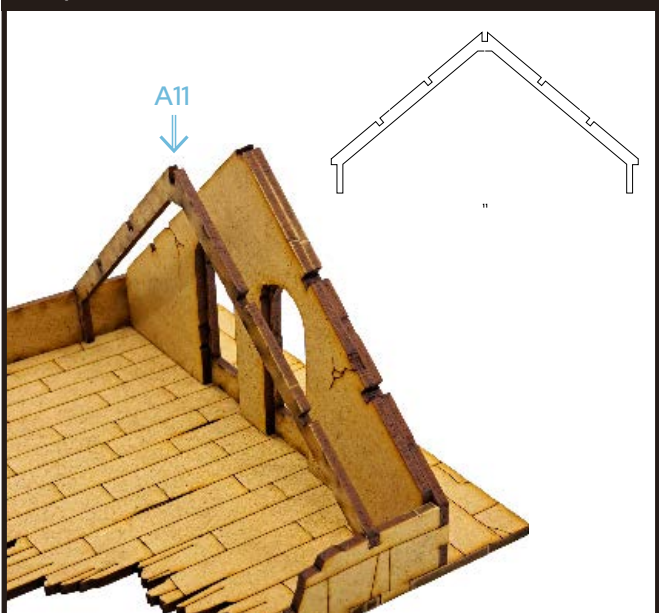

Step 22 A3



Step 23 A14 + A17 + A18

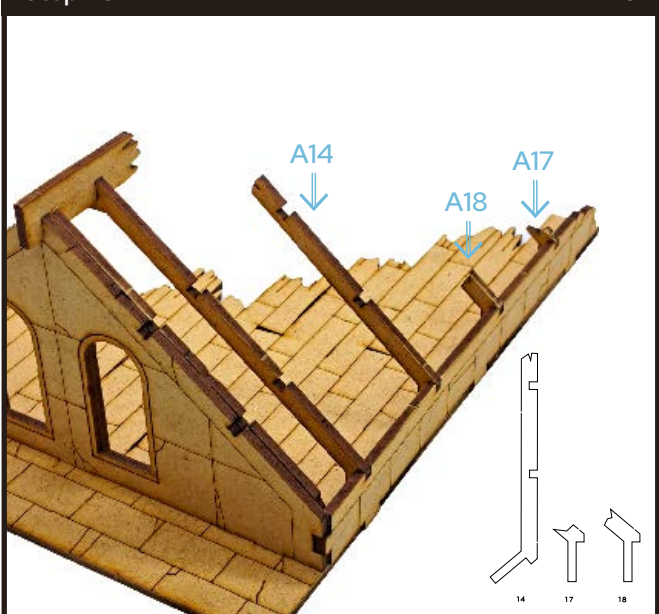

Step 24 A12 + A13

