

MEDIEVAL FANTASY COLLECTION

BURGOMEISTER'S MANOR

ASSEMBLY INSTRUCTIONS

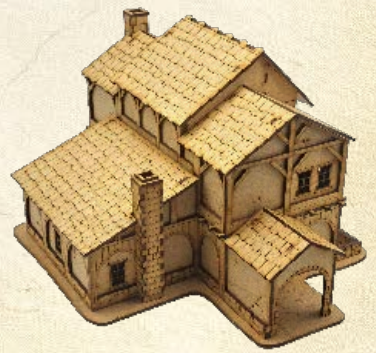
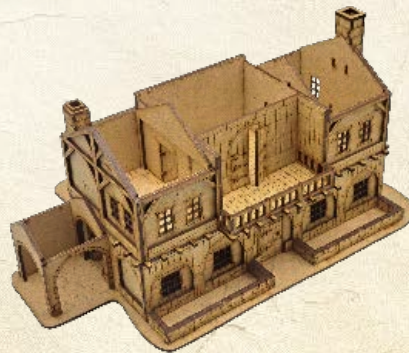

dryad-miniworlds.be

MED-005 / © DRYAD MiniWorlds 2025. All rights reserved. 100% made in Belgium.

BEFORE ASSEMBLING YOUR KIT, CAREFULLY READ THE FOLLOWING INSTRUCTIONS.

To assemble this kit, you will need several tools:

A modelling knife

Use the modelling knife to detach the pieces from their frame. Do not push them with your fingers or you might break the most fragile parts.

Sandpaper or a small wood file

Sand or file away any rough edges where the parts were attached to the panel.

Wood glue or liquid cyanoacrylate

Glue the pieces according to the assembly plan. Wood glue will take longer to dry than cyanoacrylate glue, but is easier to reposition in case of error.

When assembling this kit, make sure the pieces fit together properly before gluing them together.

You may find some of these icons in the assembly plan. They will provide you with additional information for your assembly.



Indicates the direction of gluing



Do not glue



Align



Important note



Construction stage



End of stage



Assembly alternatives

AVANT D'ASSEMBLER VOTRE KIT, LISEZ ATTENTIVEMENT LES INSTRUCTIONS SUIVANTES.

Pour assembler ce kit, vous aurez besoin de plusieurs outils :

Un couteau de modélisme

Utilisez le couteau de modélisme pour détacher les pièces de leur cadre. Ne poussez pas avec vos doigts car vous risqueriez de casser les pièces les plus fragiles.

Du papier abrasif ou une petite lime à bois

Poncez ou limez les aspérités, là où les pièces étaient attachées au panneau.

De la colle à bois ou cyanoacrylate liquide

Collez les pièces suivant le plan de montage. La colle à bois mettra plus de temps à sécher que la colle cyanoacrylate, mais est plus facilement repositionnable en cas d'erreur.

Lorsque vous assemblez ce kit, vérifiez avant de coller si les pièces s'emboîtent correctement.

Vous trouverez peut-être certaines de ces icônes dans le plan de montage. Elles vous fourniront des informations complémentaires pour votre assemblage.



Indique la direction du collage

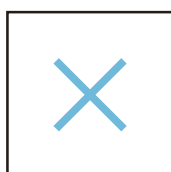

Ne pas coller

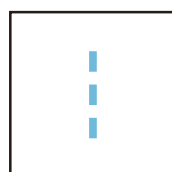

Aligner



Remarque importante

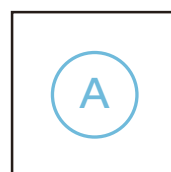

Etape de construction



Fin d'étape



Alternatives de montage

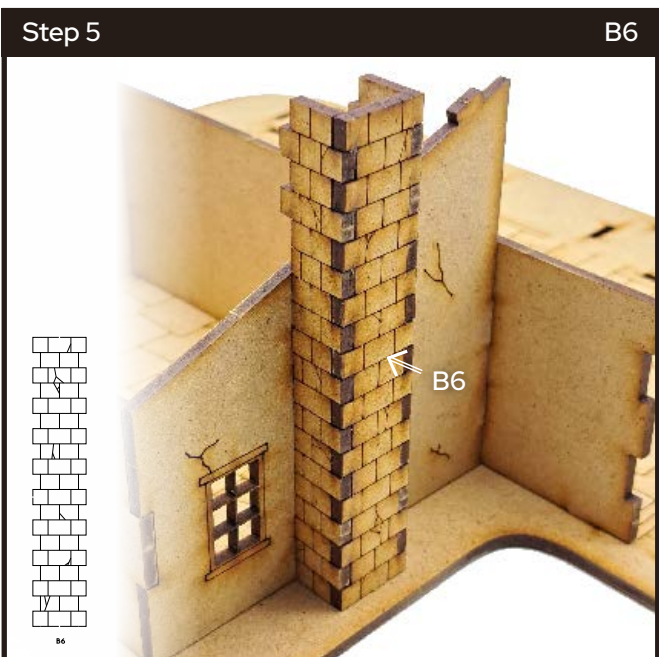
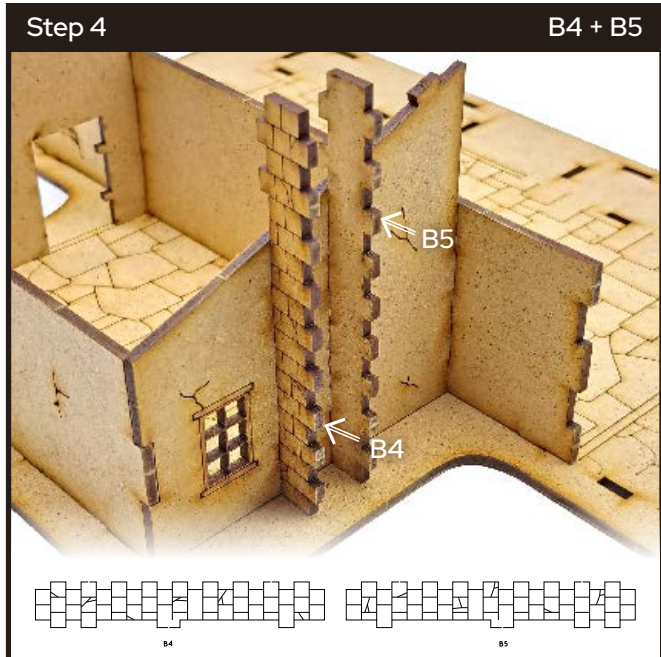
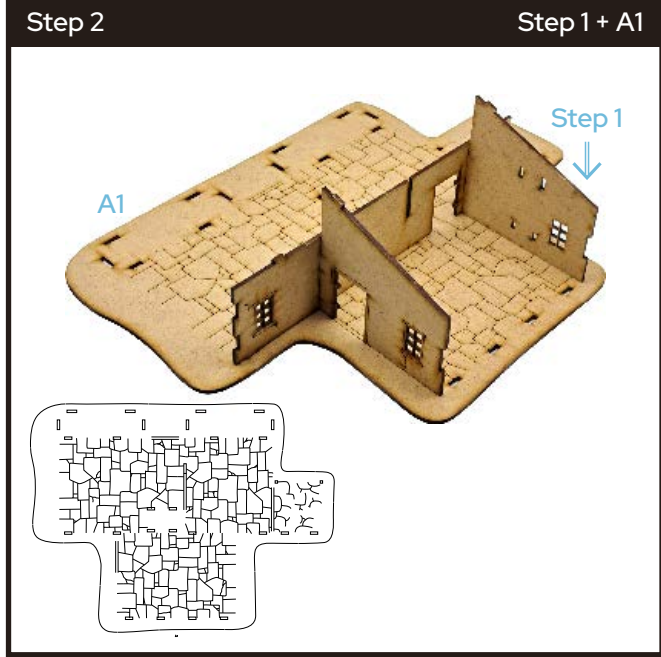
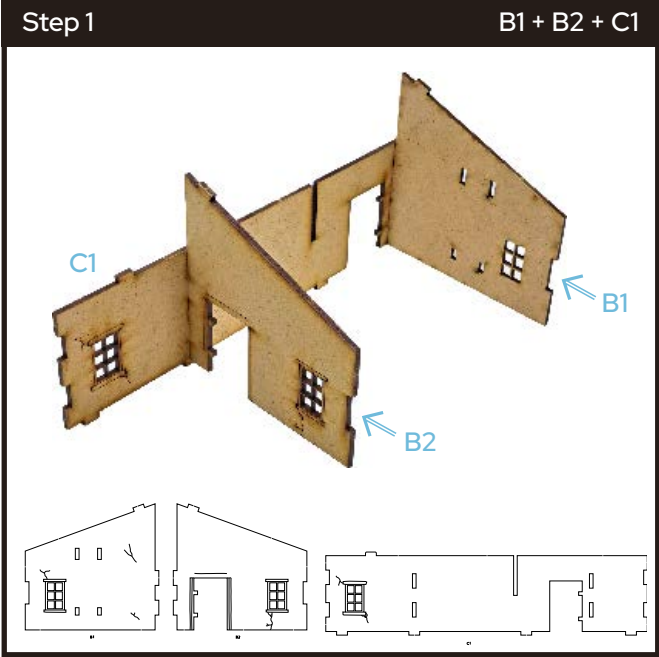

Step 7 B8 + B9

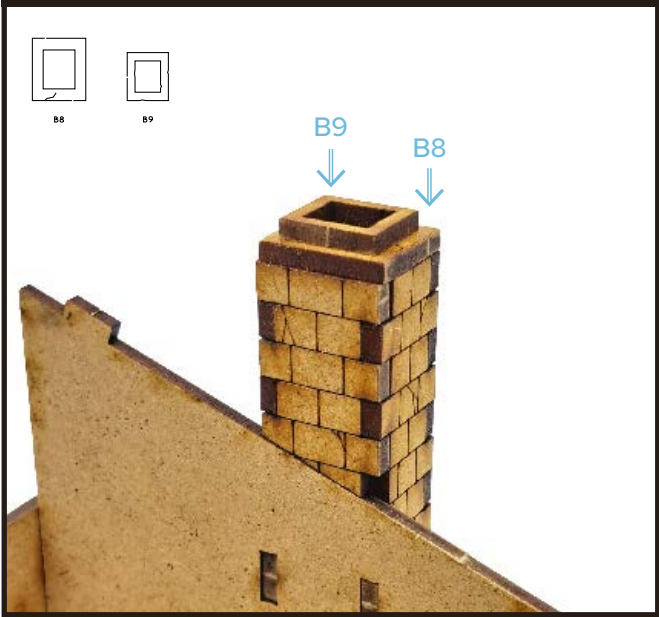

Step 8 B10

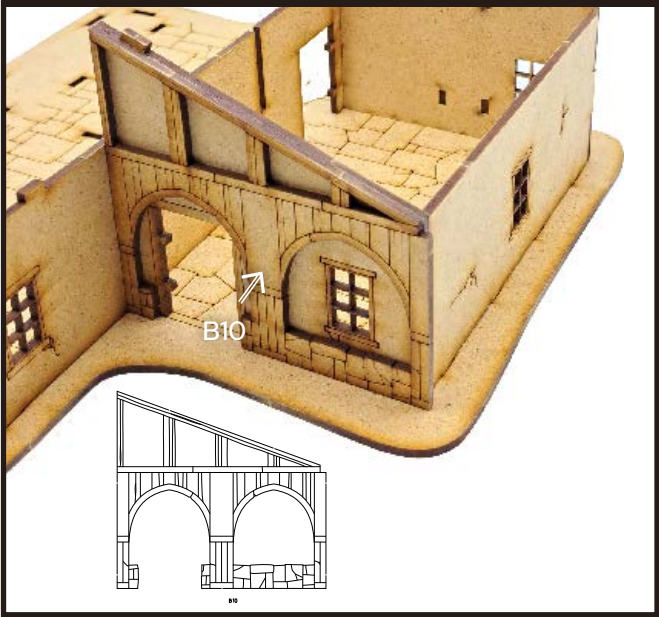

Step 9 B13



Step 10 B11 + B12

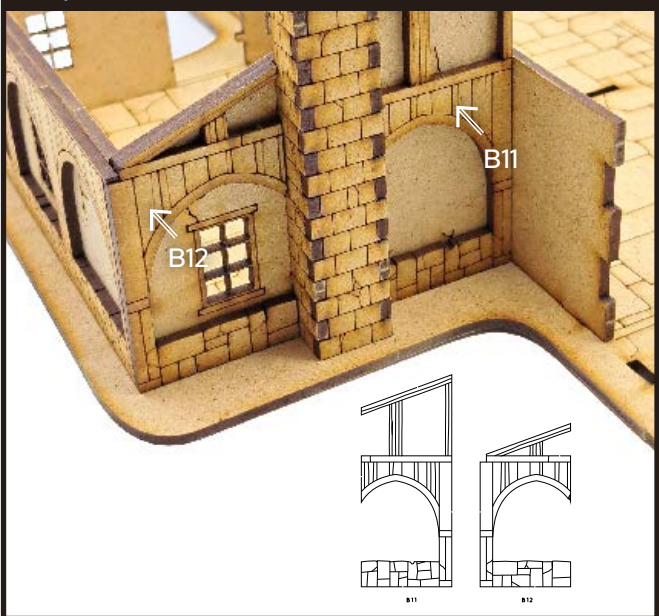

Step 11 B14

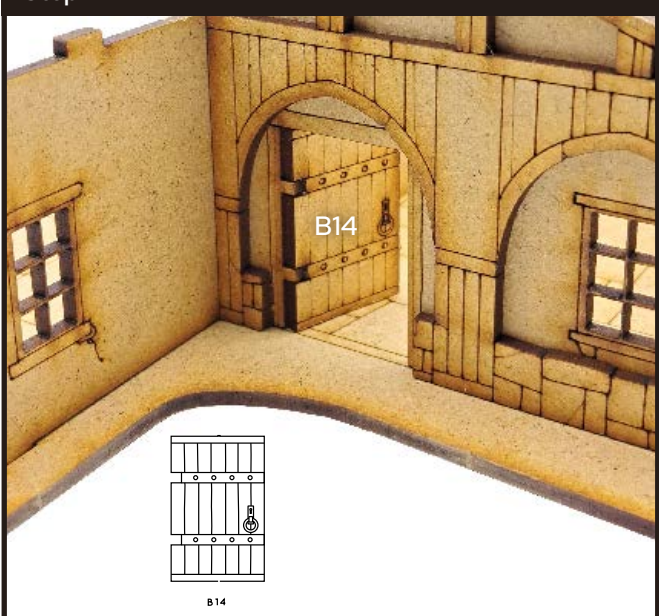

Step 12 C2

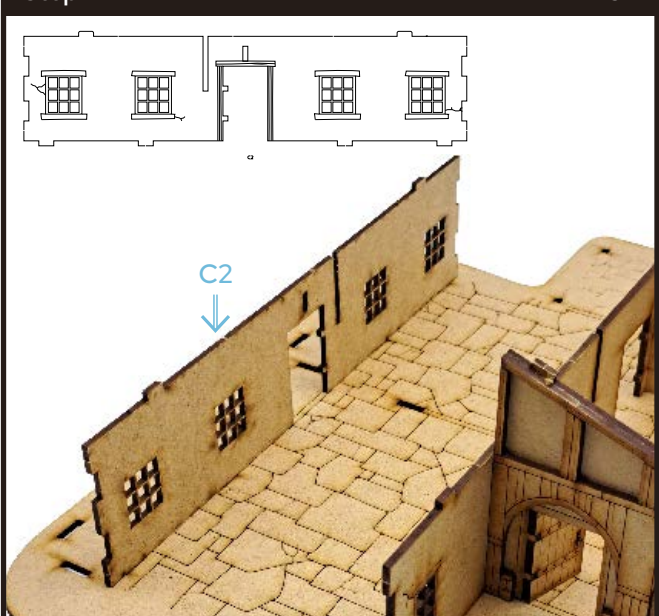

Step 13

C11

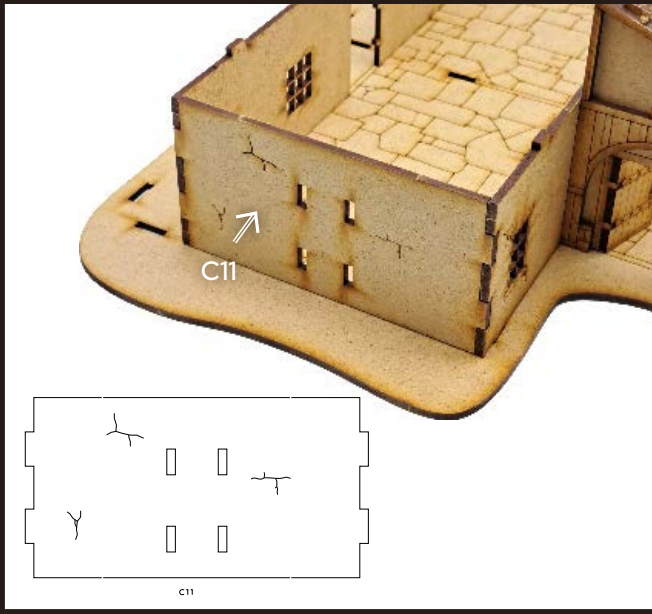

Step 14

D4 + D5 + D6

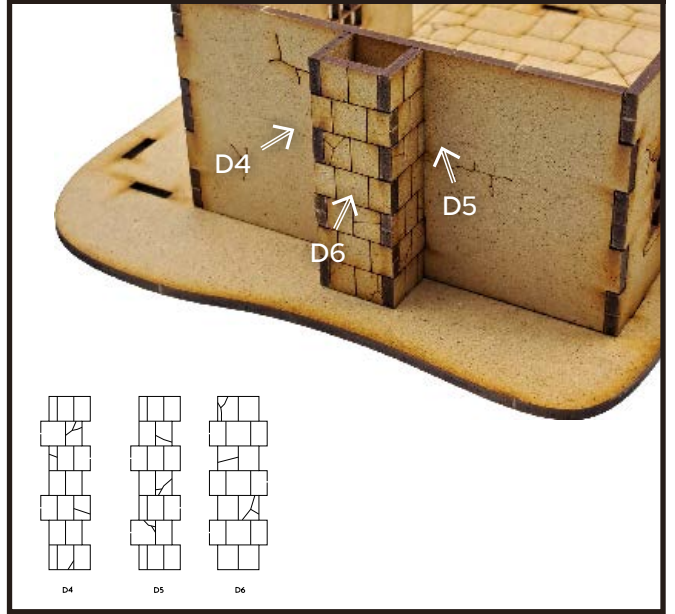

Step 15

C17 + C18

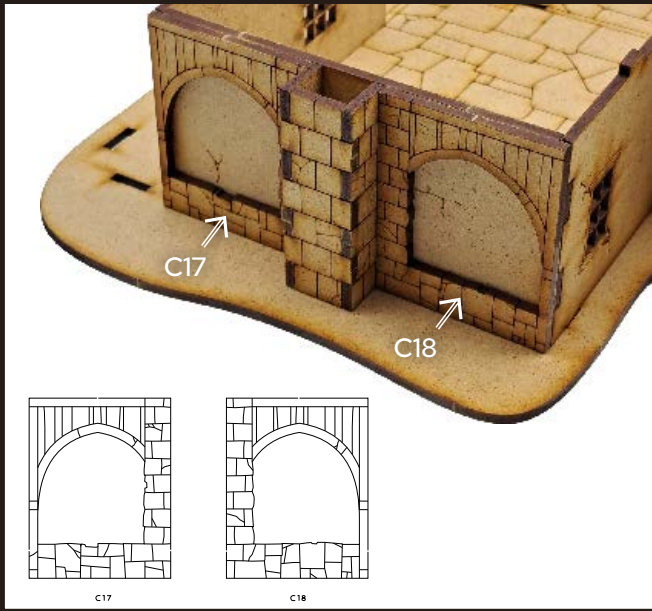

Step 16

D7

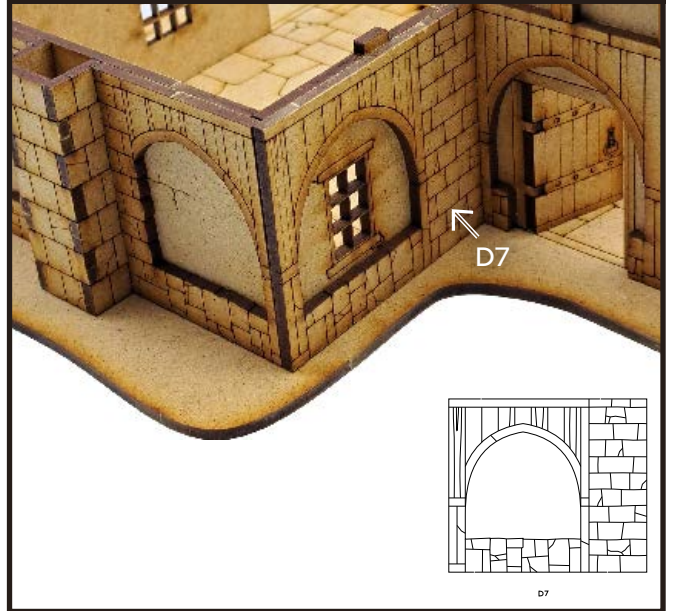

Step 17

C10

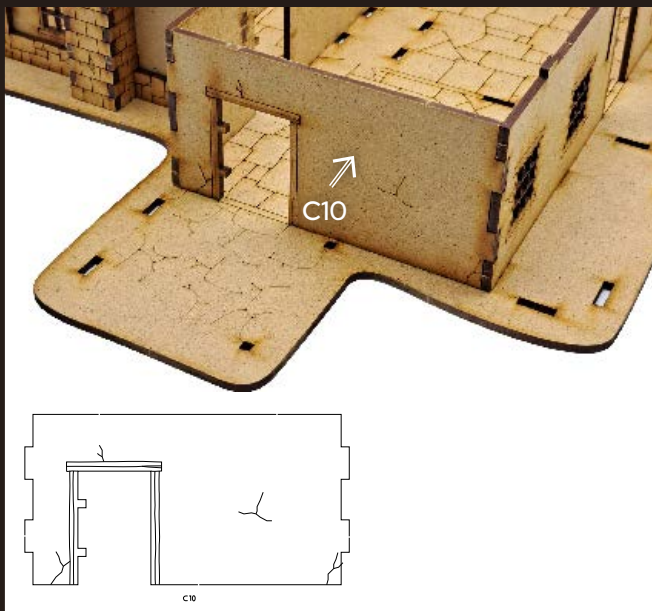

Step 18

G10 + G12

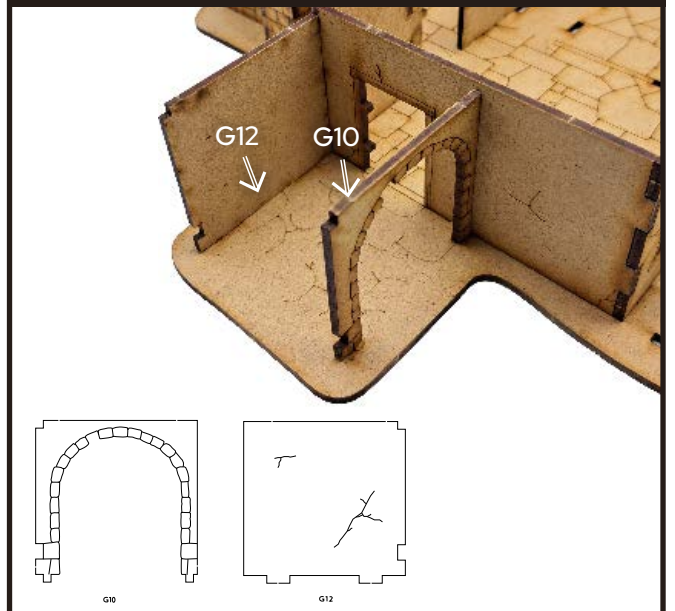

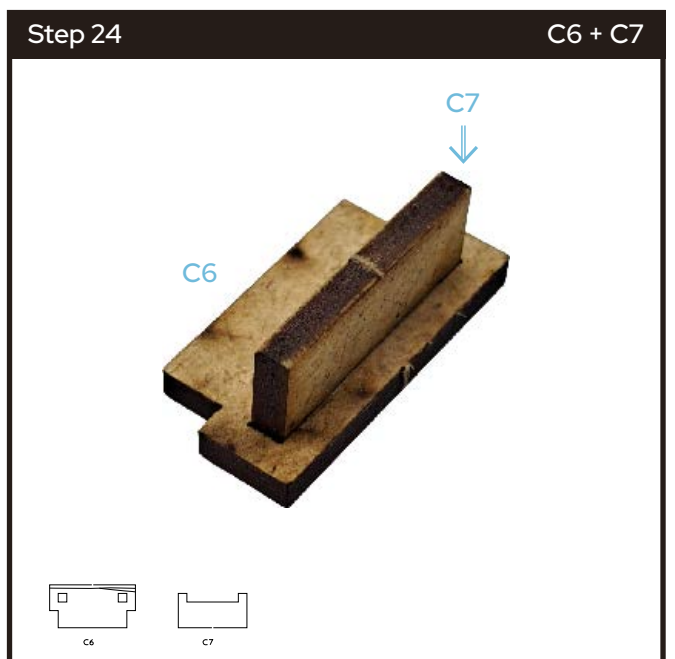
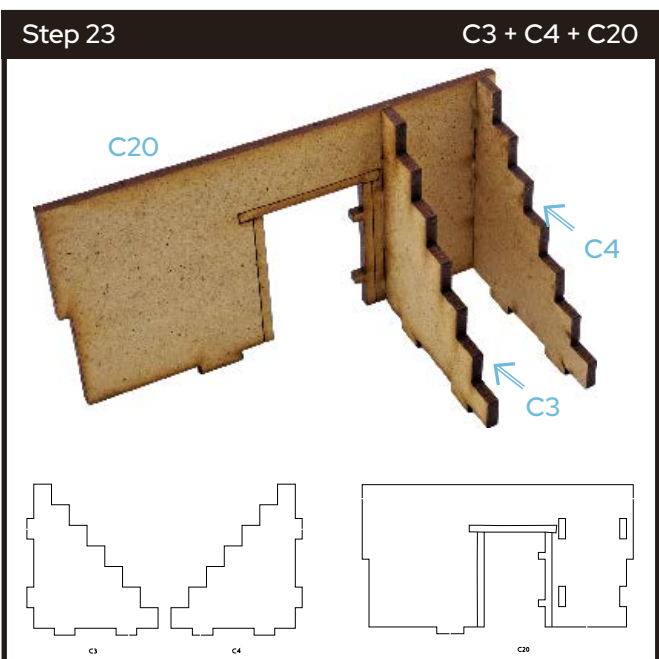
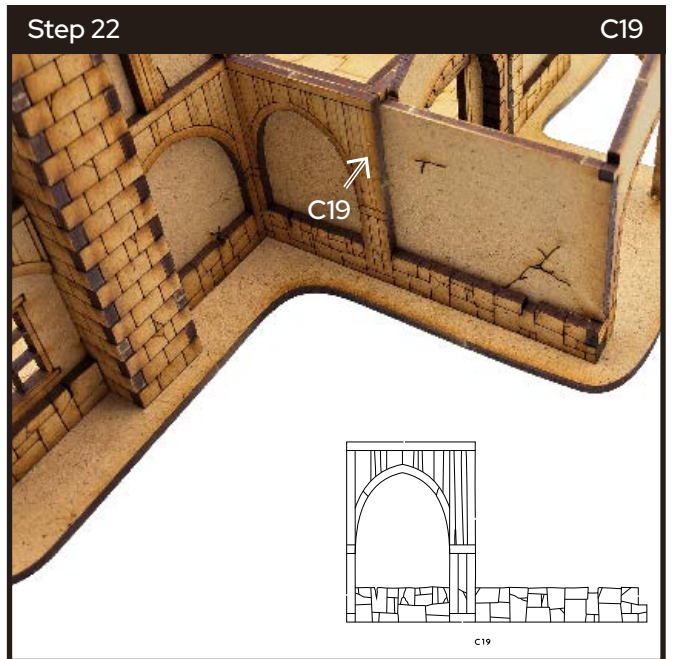
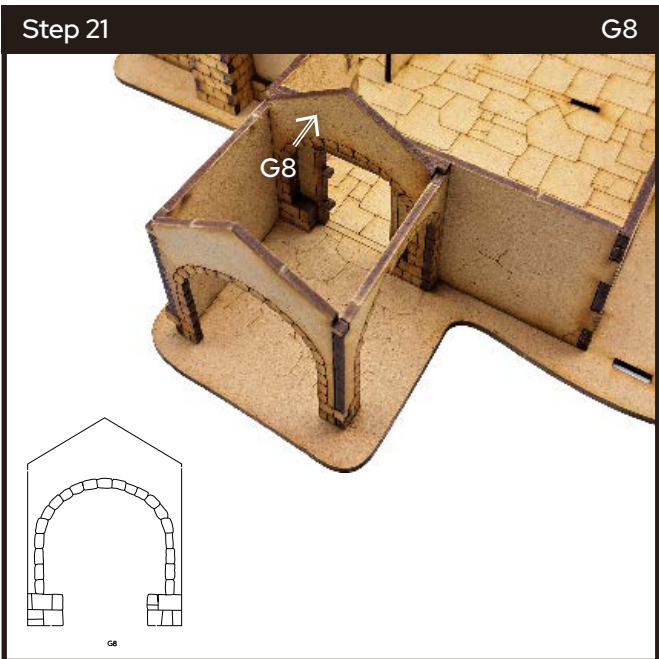
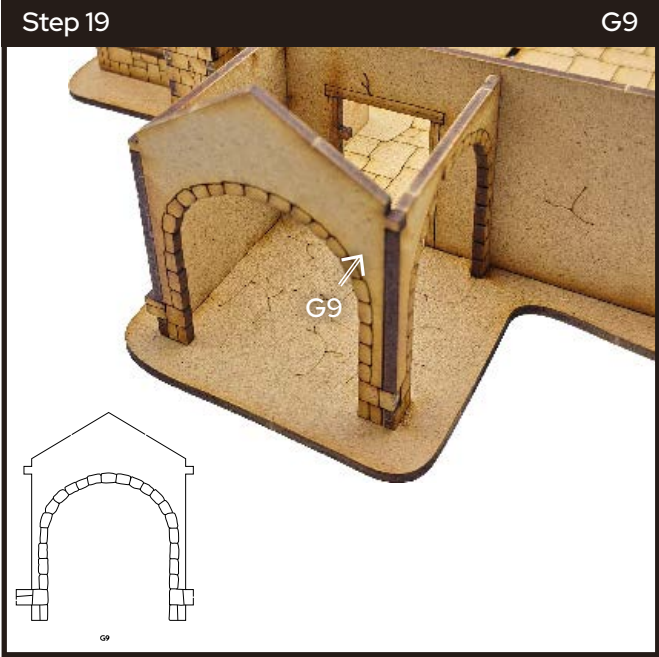

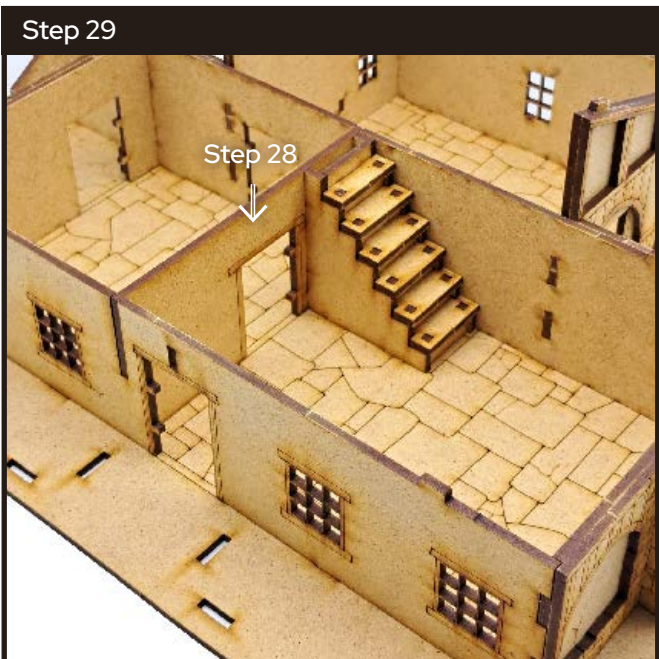
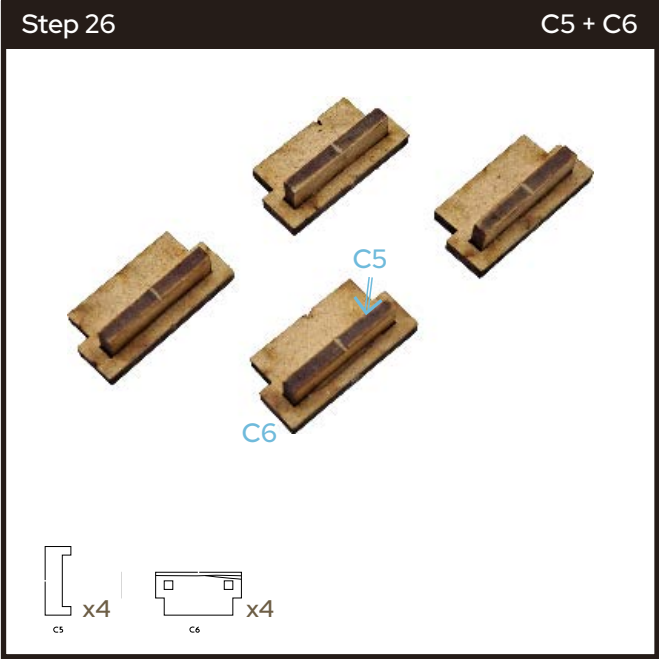

Step 31 C13 + C16

← C16

← C13

C13 C16

Step 32 D1

D1

D1

Step 33 D2 + D3

D2

D3

D2

D2 x2 D3

Step 34 C15

C15

C15

Step 35 A3 + A4

A4

A3

A4

A3

A3 A4

Step 36 A2

A2

A2

A2

Step 37

A5 + A6 + A7

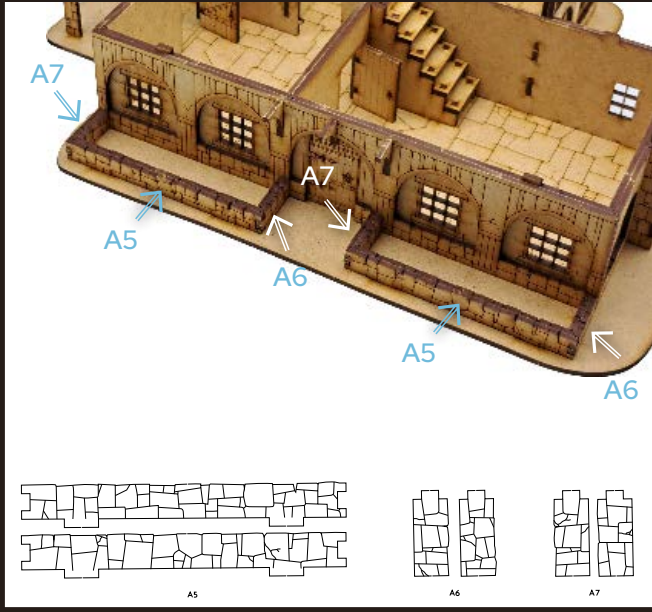

Step 38

C14

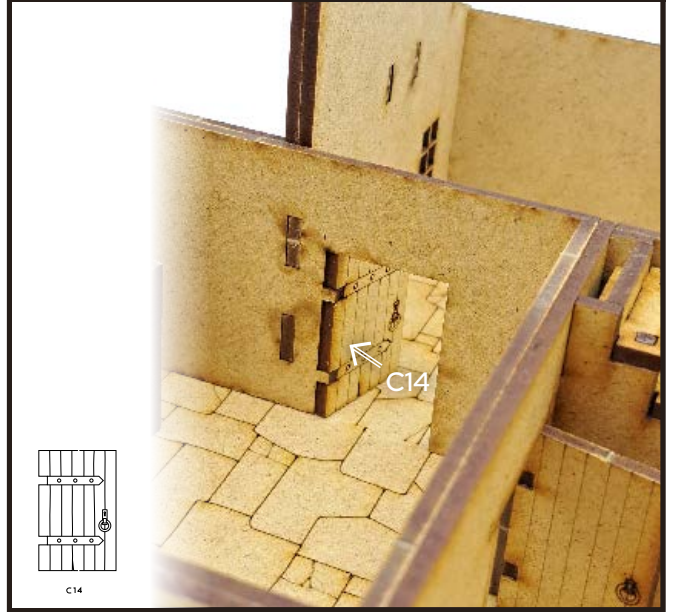

Step 39

F1 + F2 + F3

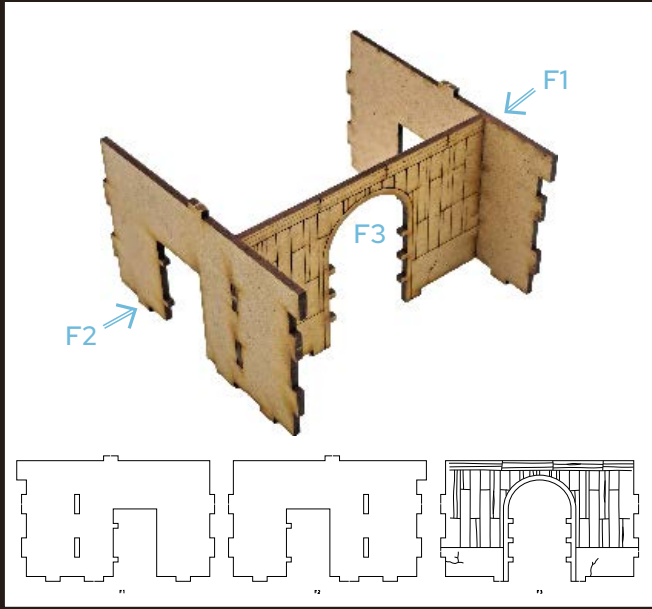

Step 40

E1 + E3 + Step 39

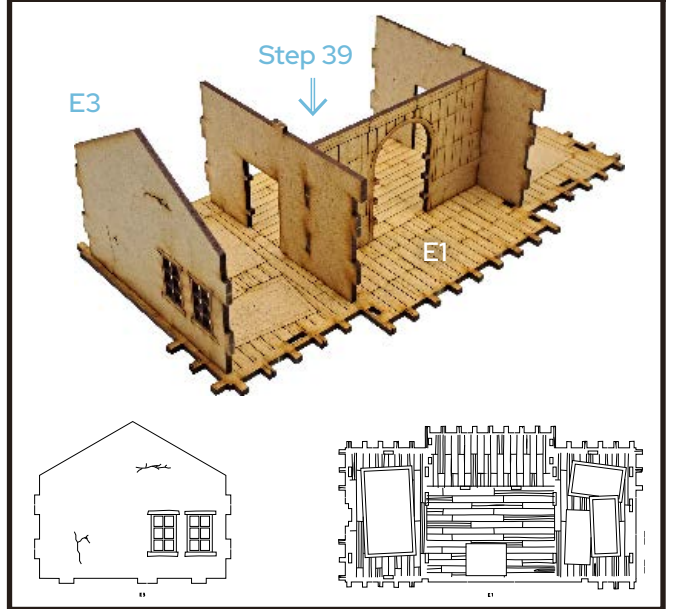

Step 41

E4

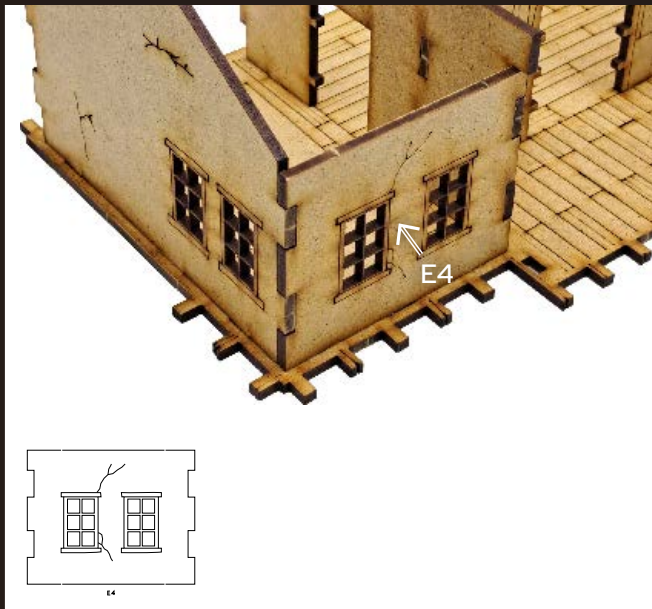

Step 42

D19 + D20

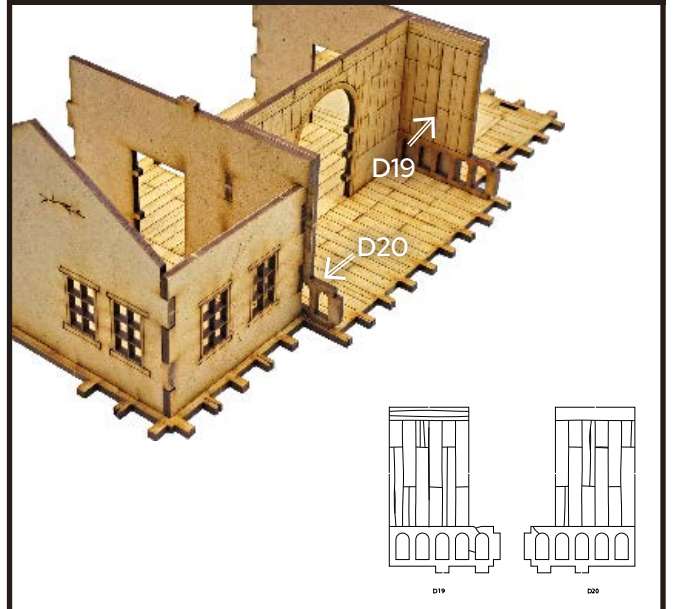

Step 43 E6

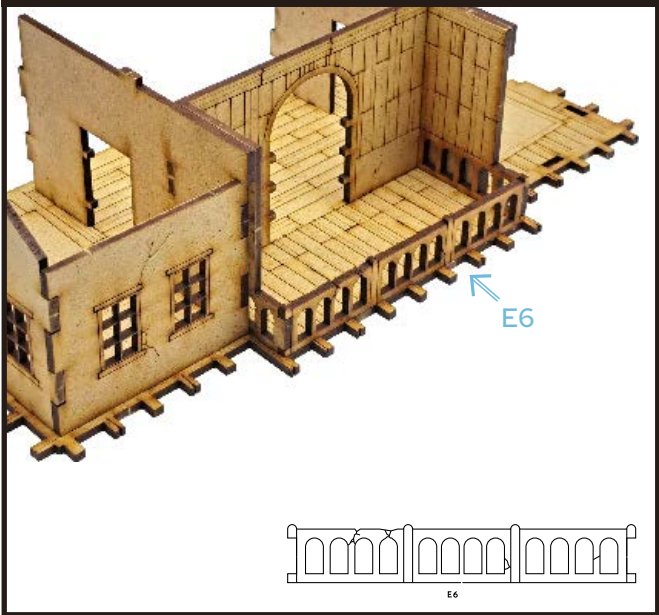

Step 44 F5 + F6

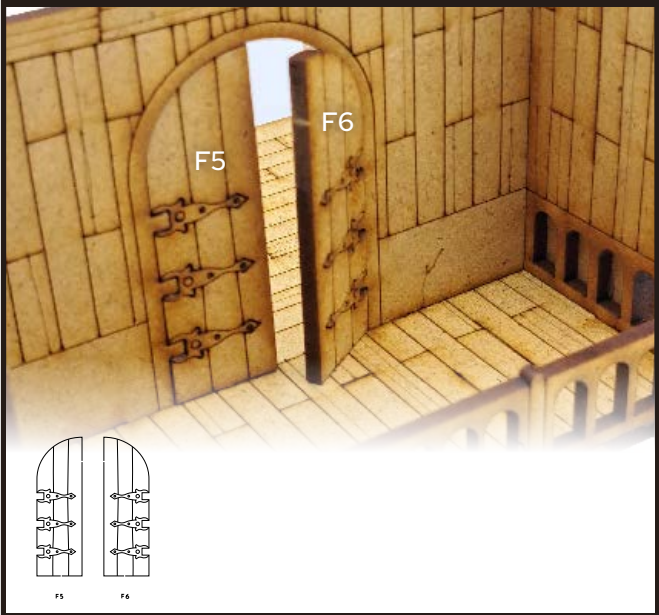

Step 45 E2

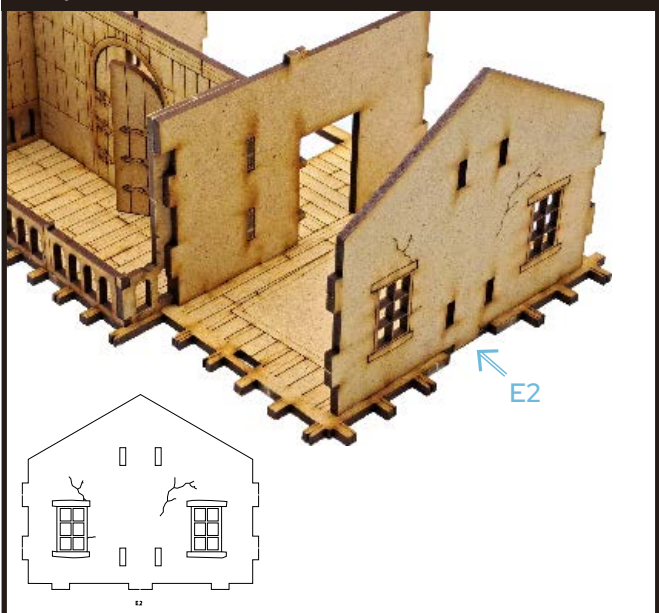

Step 46 E5

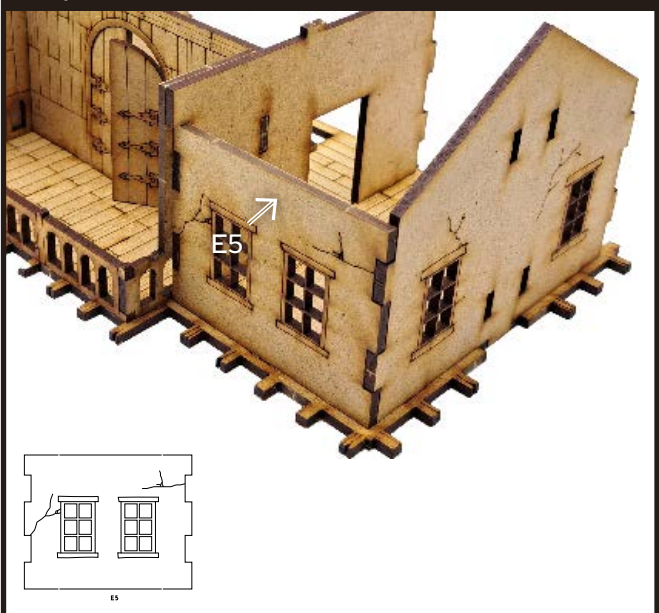

Step 47 E7 + E8

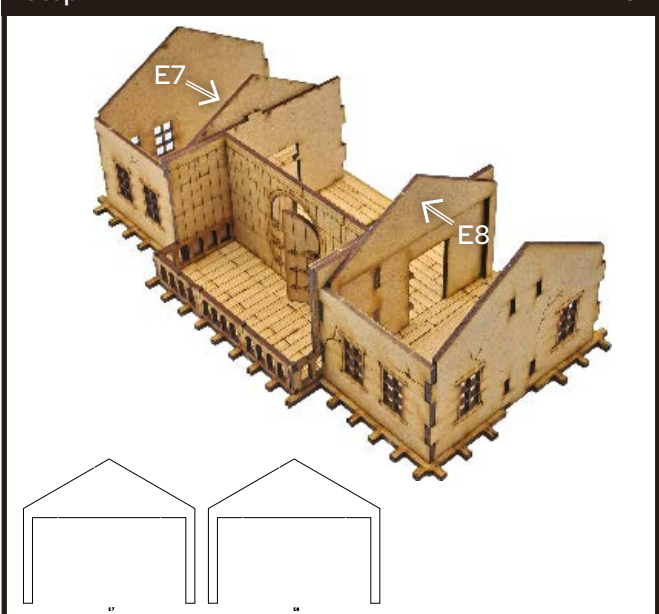

Step 48 D9 + D10

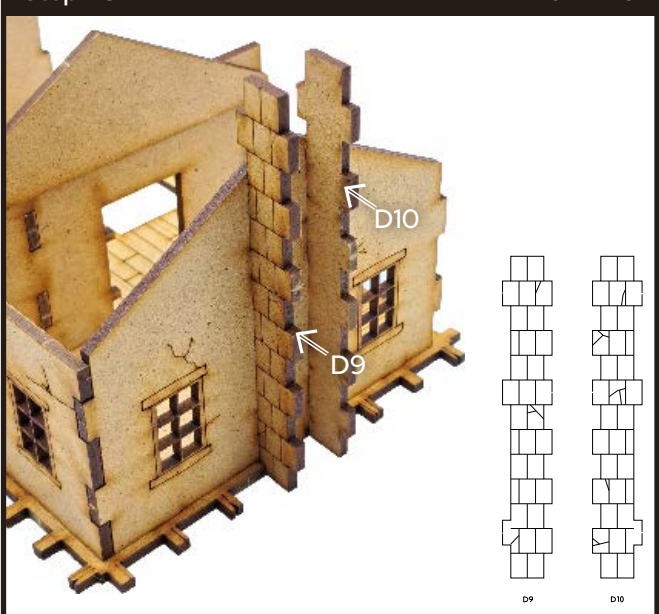

Step 49

D12

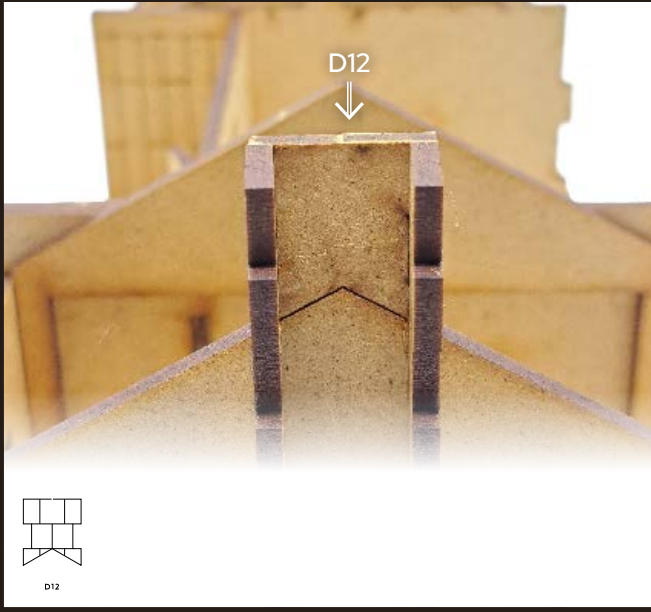

Step 50

D11

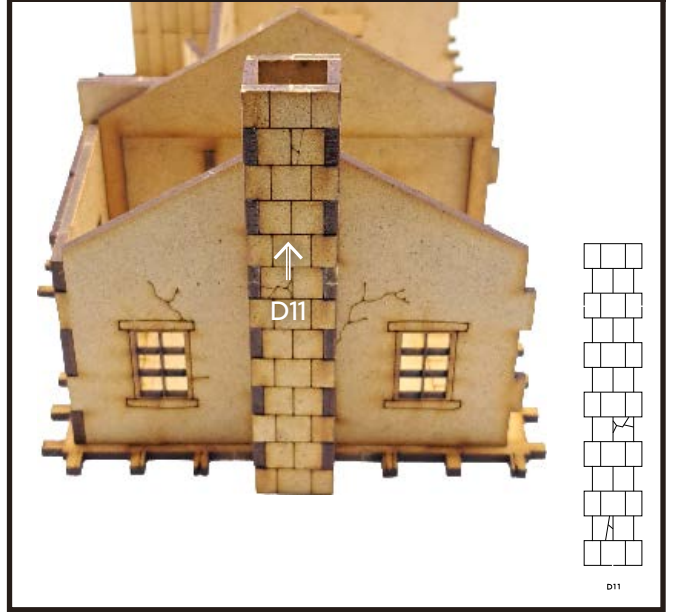

Step 51

D13

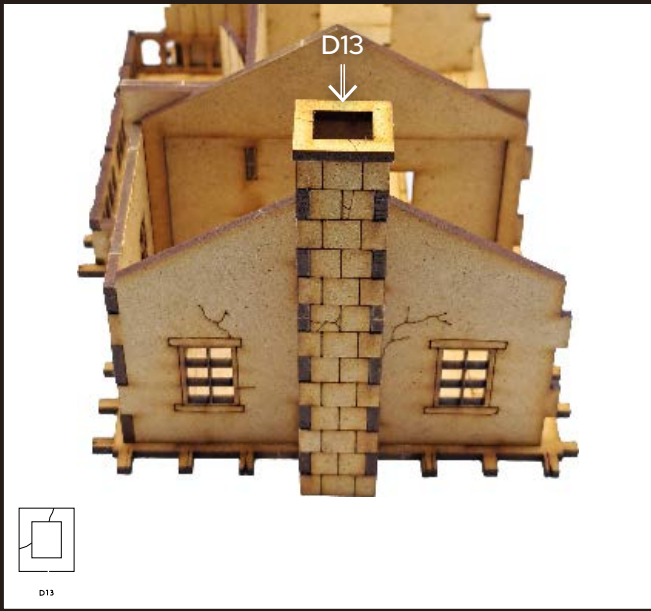

Step 52

F2

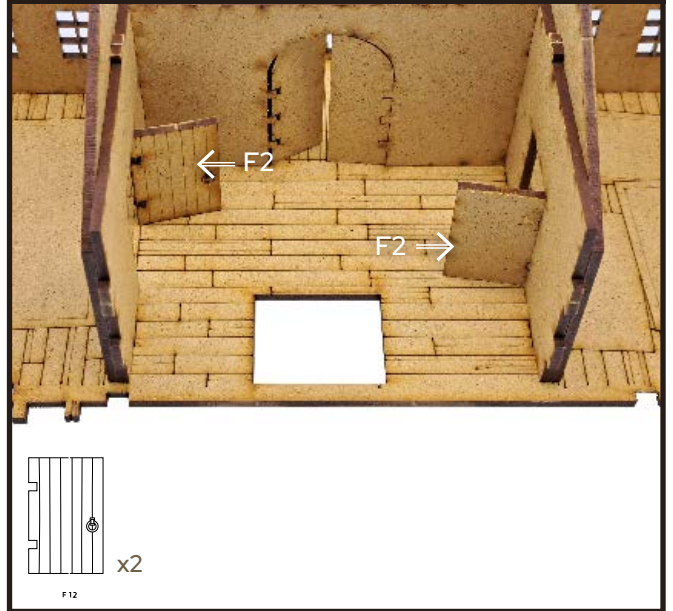

Step 53

F4

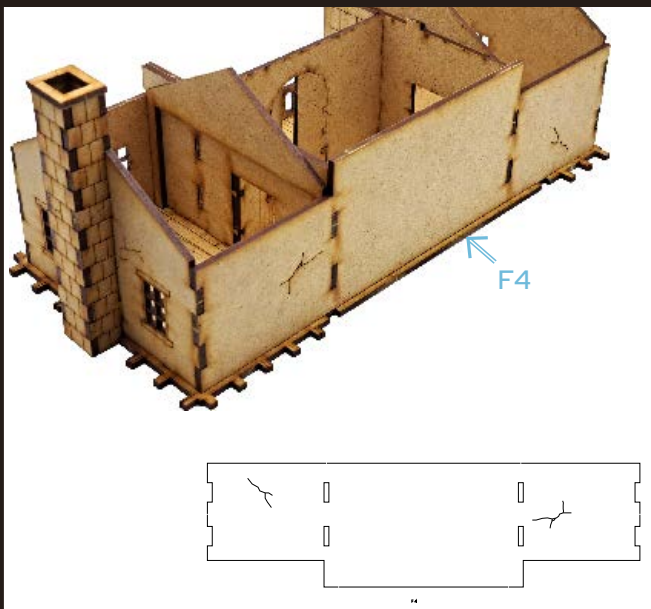

Step 54

D15 + D16

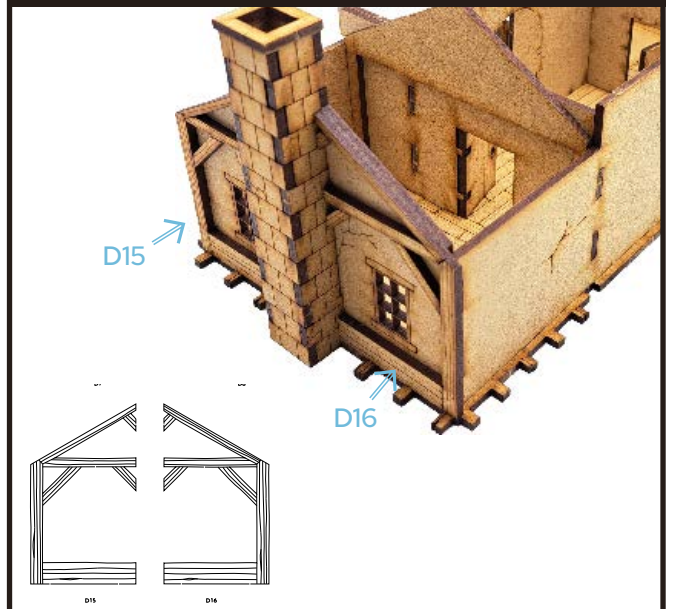

Step 55

F11

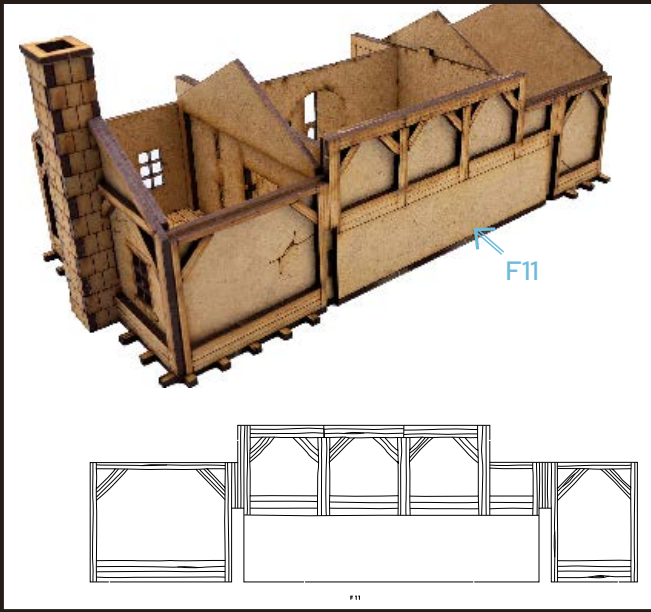

Step 56

D17

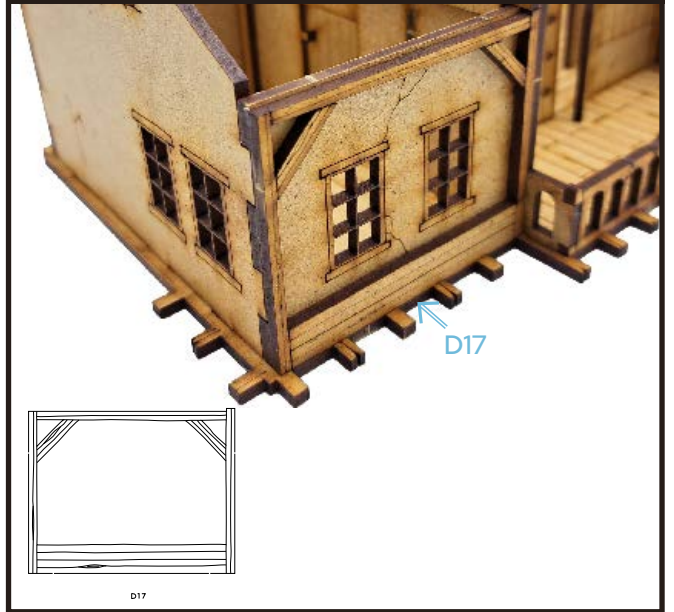

Step 57

D18

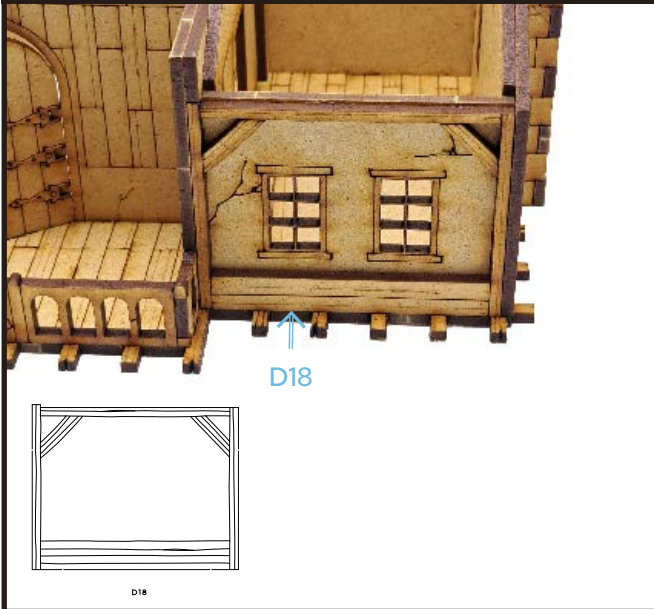

Step 58

D14

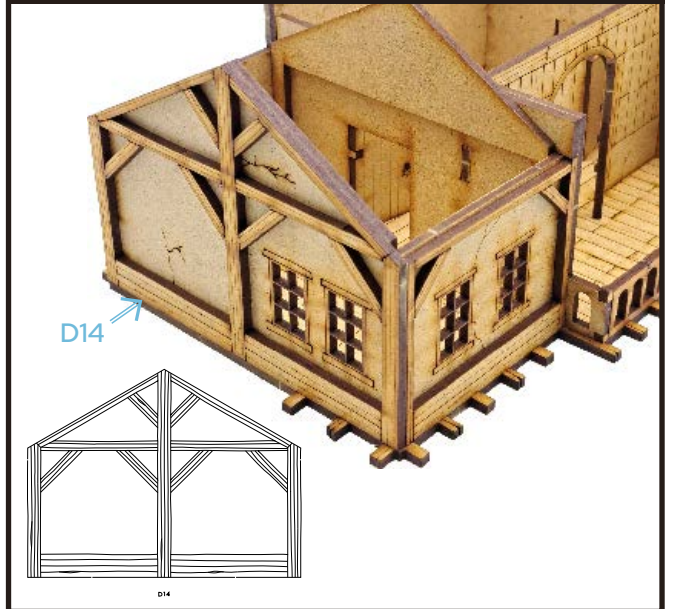

Step 59

F7 + F8

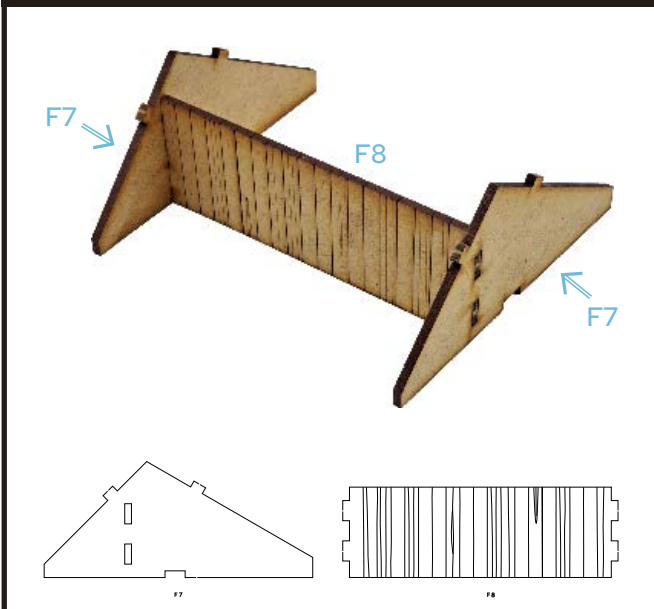

Step 60

F9

