

MEDIEVAL FANTASY COLLECTION

TOWN HOUSE

ASSEMBLY INSTRUCTIONS



BEFORE ASSEMBLING YOUR KIT, CAREFULLY READ THE FOLLOWING INSTRUCTIONS.

To assemble this kit, you will need several tools:

A modelling knife

Use the modelling knife to detach the pieces from their frame. Do not push them with your fingers or you might break the most fragile parts.

Sandpaper or a small wood file

Sand or file away any rough edges where the parts were attached to the panel.

Wood glue or liquid cyanoacrylate

Glue the pieces according to the assembly plan. Wood glue will take longer to dry than cyanoacrylate glue, but is easier to reposition in case of error.

When assembling this kit, make sure the pieces fit together properly before gluing them together.

You may find some of these icons in the assembly plan. They will provide you with additional information for your assembly.



Indicates the direction of gluing



Do not glue



Align



Important note



Construction stage



End of stage



Assembly alternatives

AVANT D'ASSEMBLER VOTRE KIT, LISEZ ATTENTIVEMENT LES INSTRUCTIONS SUIVANTES.

Pour assembler ce kit, vous aurez besoin de plusieurs outils :

Un couteau de modélisme

Utilisez le couteau de modélisme pour détacher les pièces de leur cadre. Ne poussez pas avec vos doigts car vous risqueriez de casser les pièces les plus fragiles.

Du papier abrasif ou une petite lime à bois

Poncez ou limez les aspérités, là où les pièces étaient attachées au panneau.

De la colle à bois ou cyanoacrylate liquide

Collez les pièces suivant le plan de montage. La colle à bois mettra plus de temps à sécher que la colle cyanoacrylate, mais est plus facilement repositionnable en cas d'erreur.

Lorsque vous assemblez ce kit, vérifiez avant de coller si les pièces s'emboîtent correctement.

Vous trouverez peut-être certaines de ces icônes dans le plan de montage. Elles vous fourniront des informations complémentaires pour votre assemblage.



Indique la direction du collage

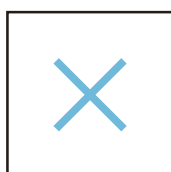

Ne pas coller

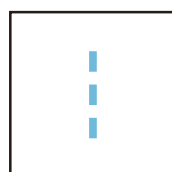

Aligner



Remarque importante

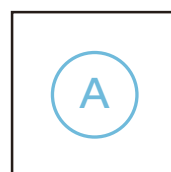

Etape de construction



Fin d'étape



Alternatives de montage

Step 1 A2 + B4 + B5

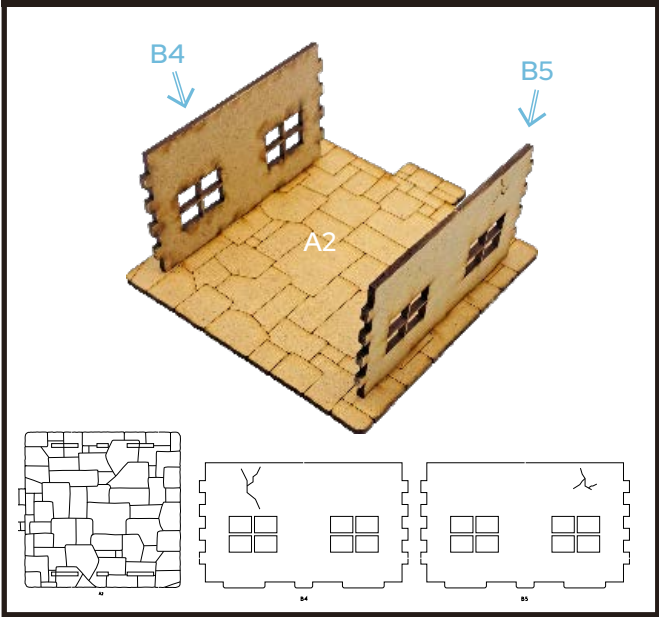

Step 2 B2

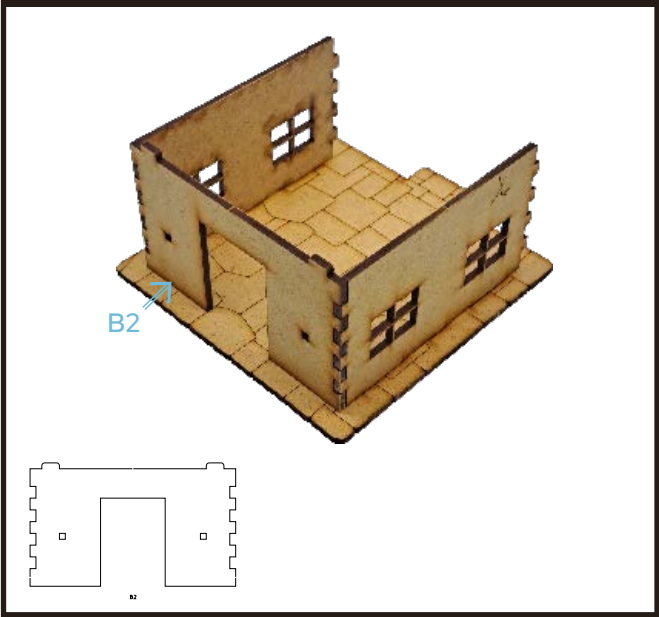

Step 3 B3

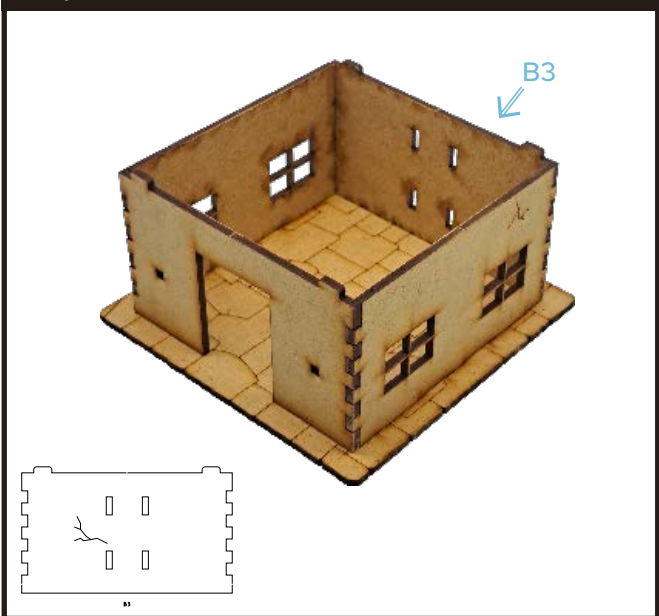

Step 4 B6 + B7

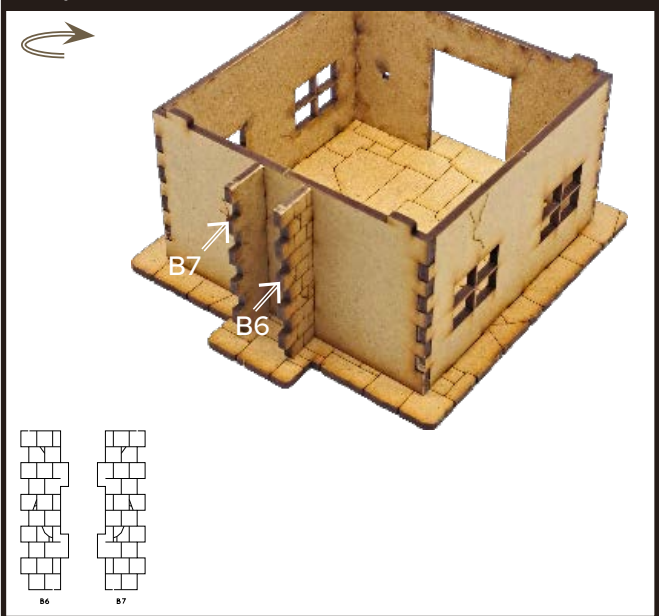

Step 5 A4

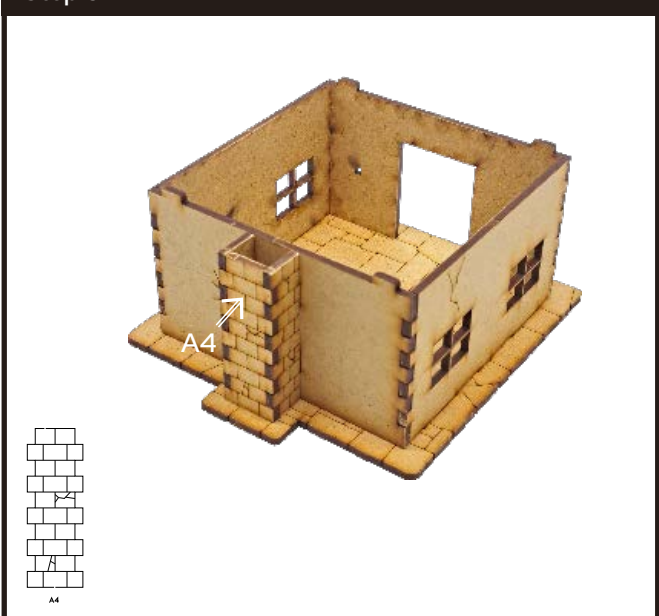

Step 6 A5 + B8

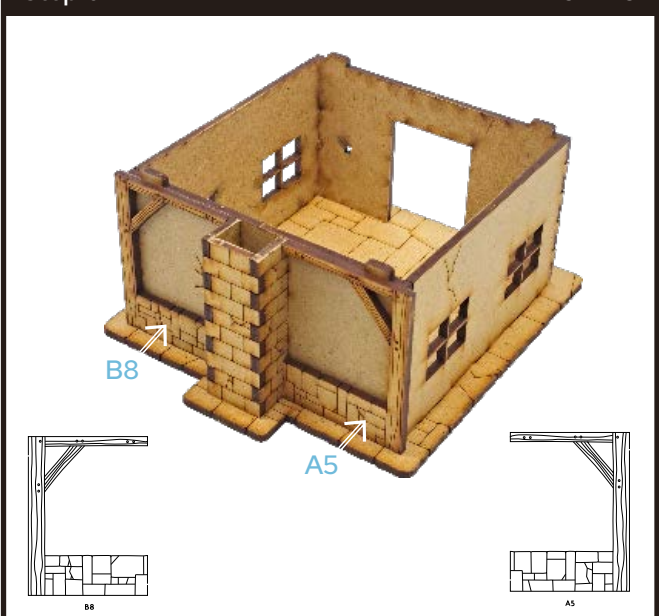

Step 7

B12

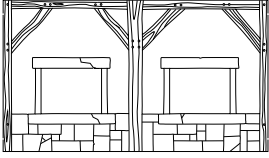

Step 8

B11

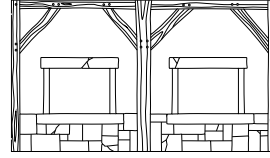

Step 9

A10

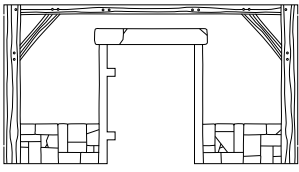
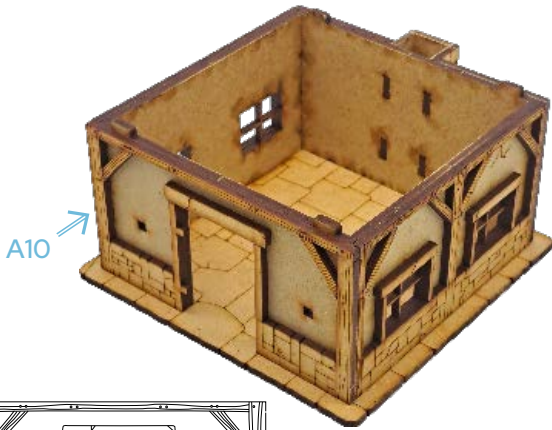

Step 10

A1 + D2 + D3

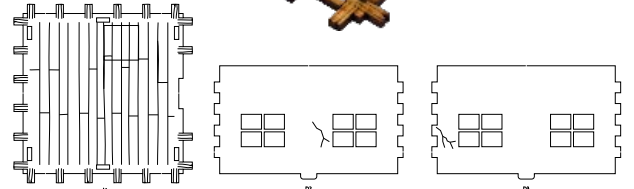
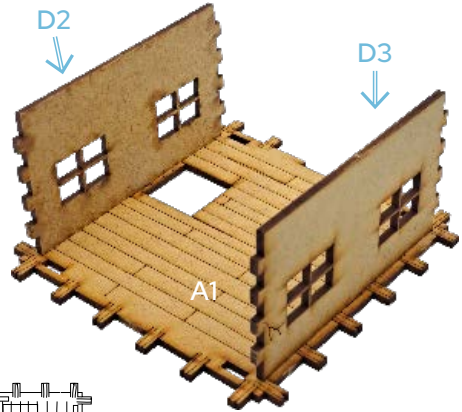

Step 11

C1 + C4

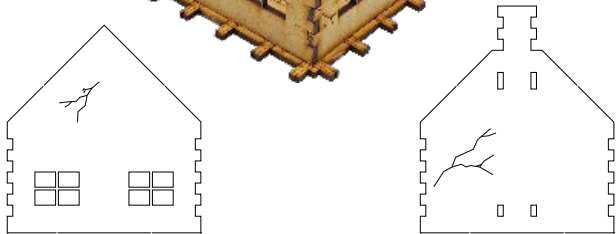
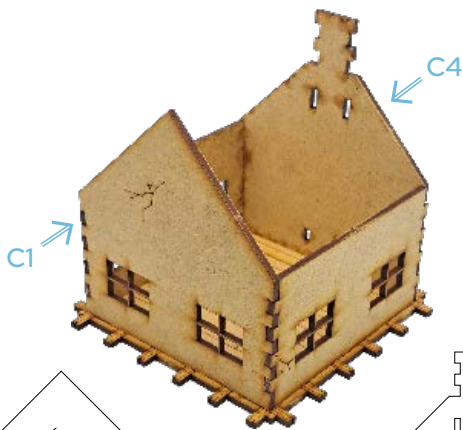

Step 12

B13 + B14

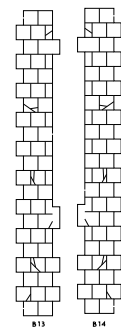
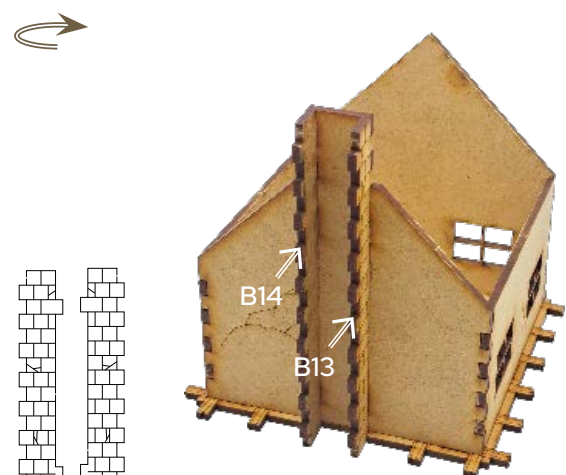

Step 13

D4

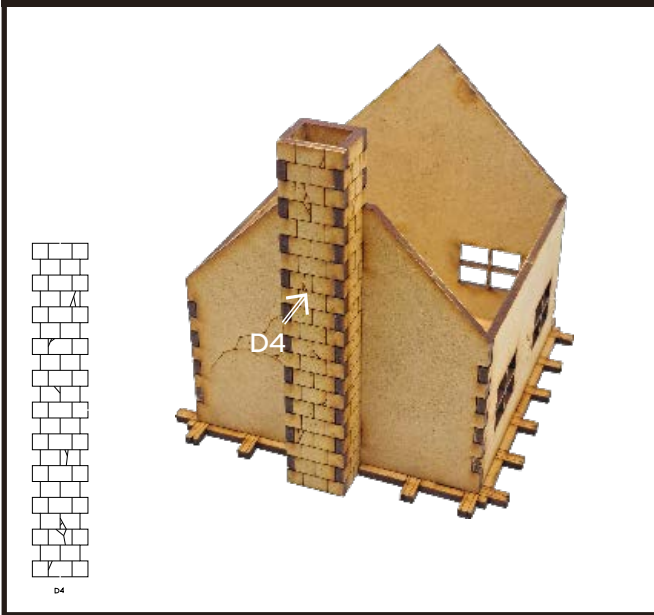

Step 14

C5 + C6

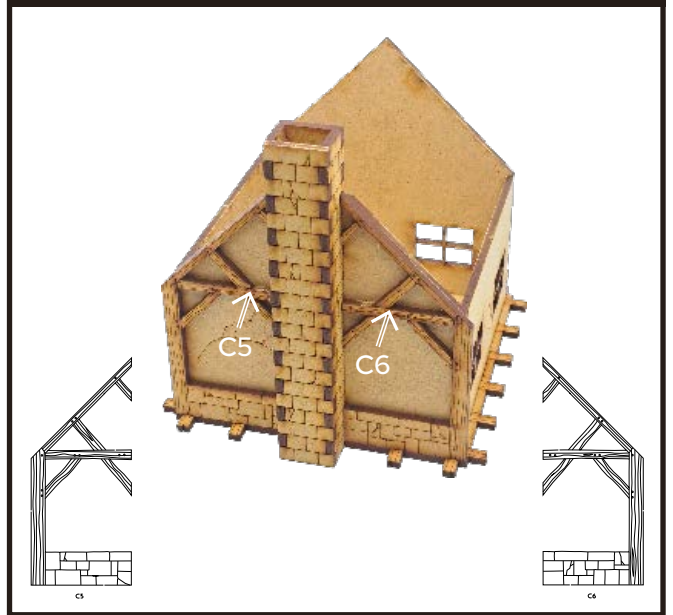

Step 15

A9

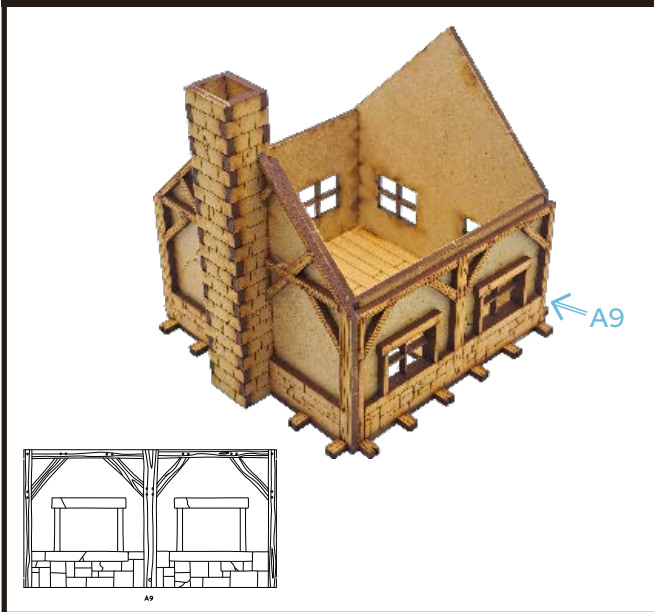

Step 16

C8

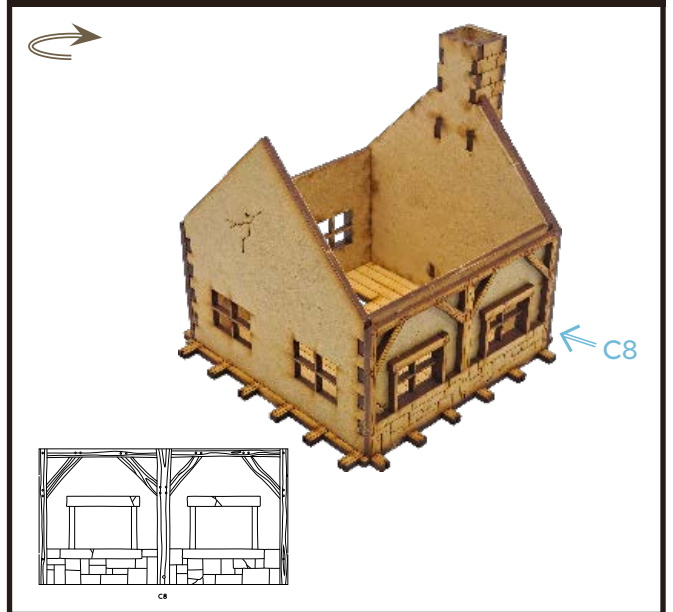

Step 17

C7

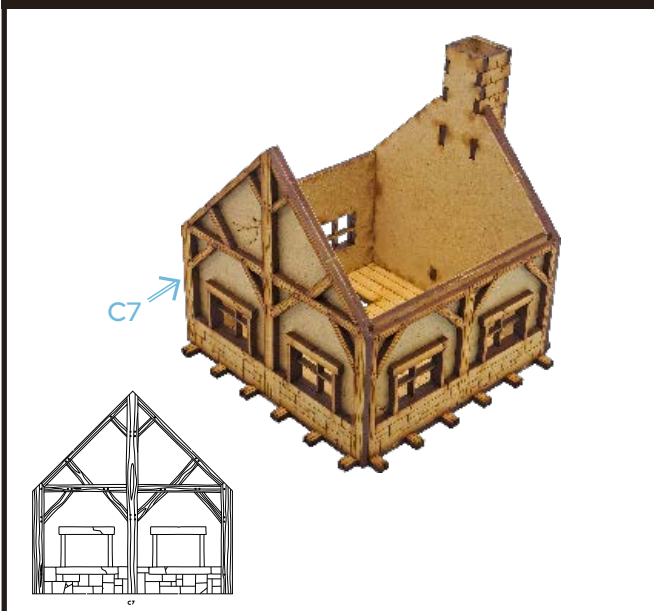

Step 18

C2 + C3

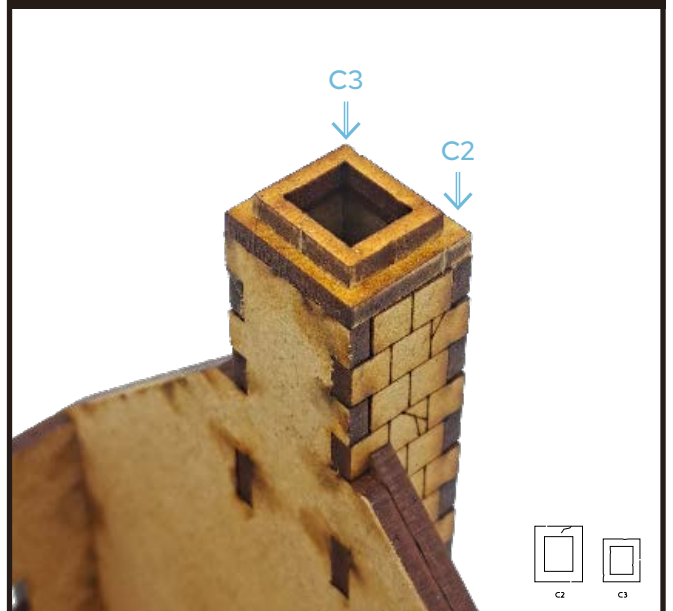

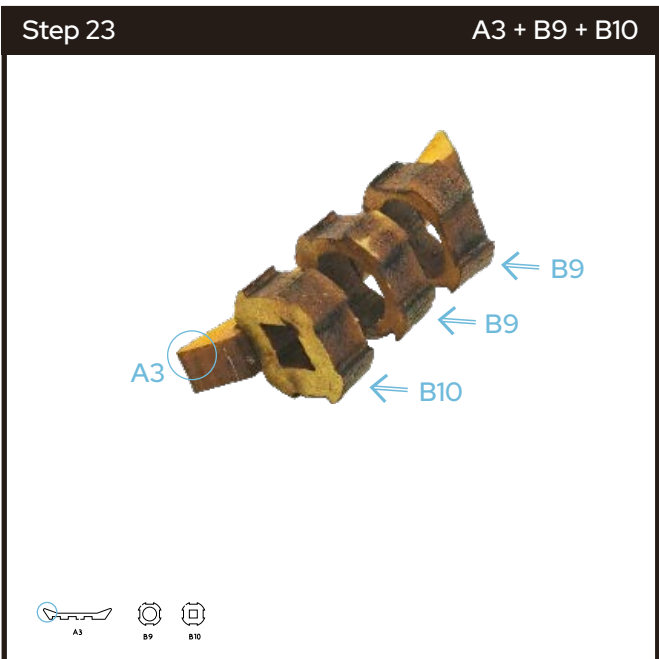
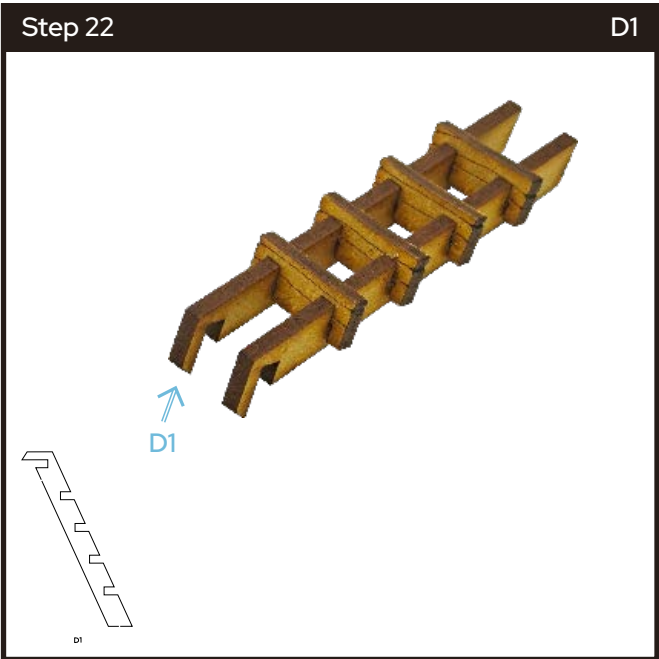
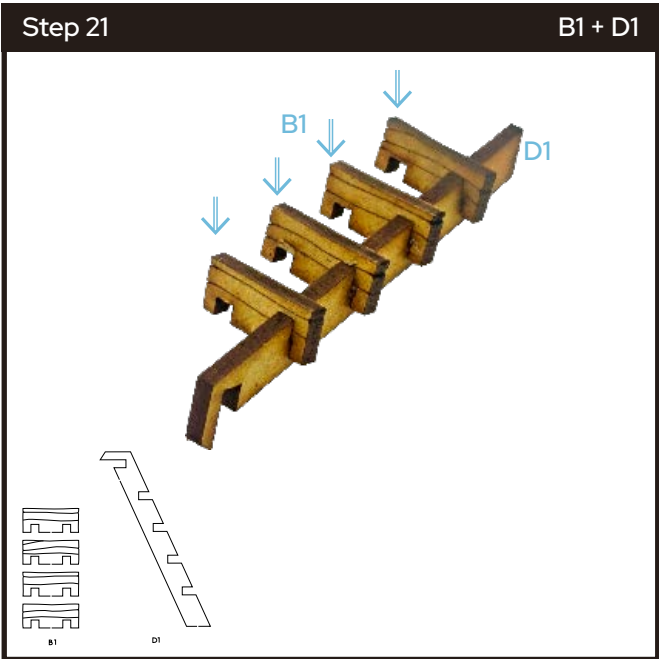
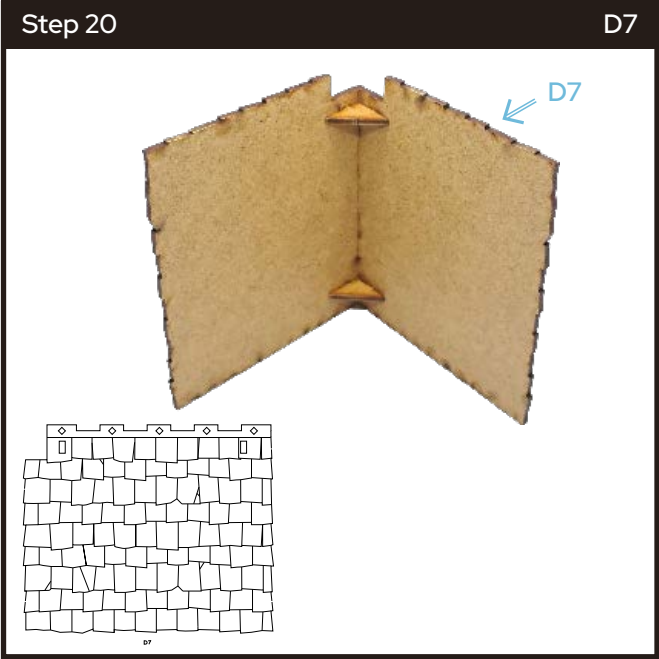
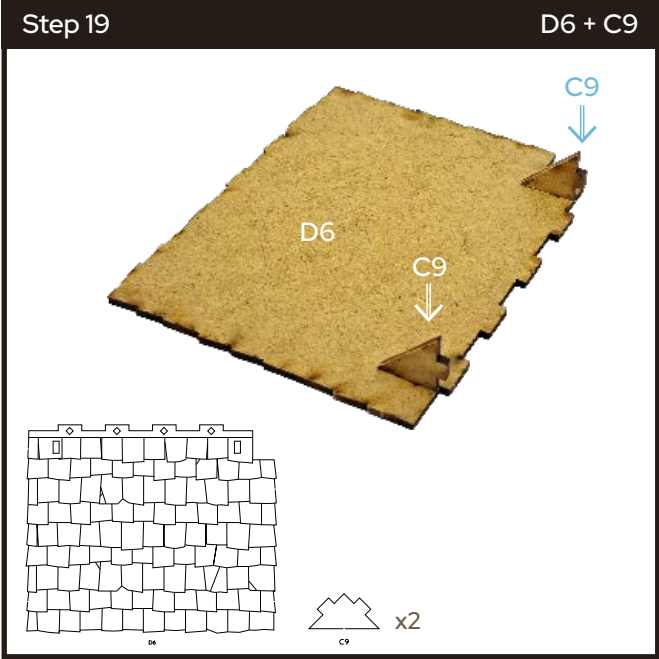

Step 25

A3

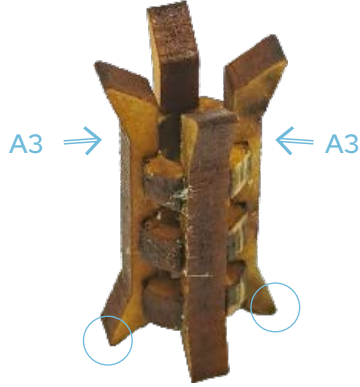

Step 26

A6



Step 27

A7 + A8



Step 28

Step 26 + Step 27

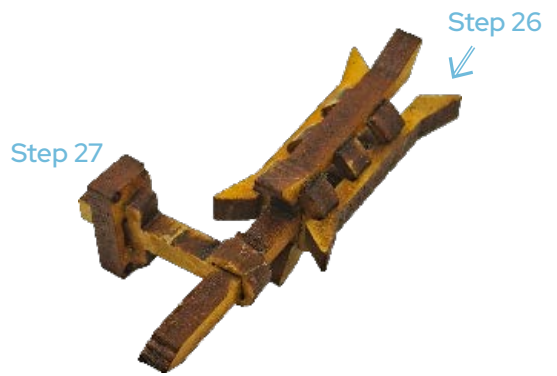

x2

Step 29

D5 + Step 28

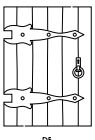
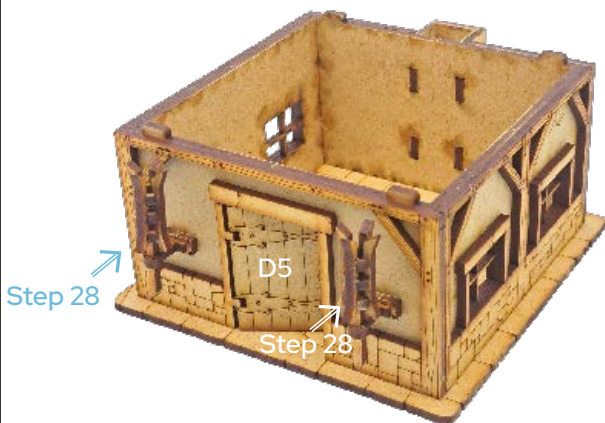

Step 30

Step 17 + Step 22

